

Series 7006 Vinyl Double Hung Windows

Visit MGMIndustries.com for a complete online catalog

Page

- 1 Singles
- 2 Twins
- 3 Triples
- 4 Quads
- 5 Fixed Pictures
- 6 Half Rounds
- 7 Transoms
- 8 Flankers
- 9 Round Top Pictures
- 10 Segment Top Pictures
- 11 Full Rounds
- 12 Ovals
- 13 Segment Top Transoms
- 14 Quarter Top, Gothic, and Half Segment Pictures
- 15 Quarter Rounds
- 16 Octagons
- 17 Triangle
- 18 Isosceles Triangle
- 19 Eyebrow
- 20 Arch Top
- 21 Arch Top Picture
- 22 Pentagon
- 23 Hexagon, Hex Head, and Half Hex Head
- 24 Trapezoid
- 25 Rough Opening Chart 1
- 26 Rough Opening Chart 2
- 27 Egress Chart

Series 7006 Product Information

<u>Test</u>	<u>Result</u>
- Air Infiltration	0.30 cfm/sq.ft.
- Water Resistance at 5 gph/sq.ft.	No Leakage
- Water Resistance Rating	DP=40 PSF
- Design Pressure	30 PSF
- Max. structural pressure achieved	45 PSF
- Overall rating	H-R25-44x60
- R Value standard clear glass	2.12*
- U Value standard clear glass	0.47
- R Value Low-E glass	2.86
- U Value Low-E glass	0.35

* Complete operating unit tested

Minimum and Maximum Build Size

		Double Hung Window Width						
		1-4	2-0	2-4	3-0	3-4	3-8	4-0
H E I G H T	2-5	yes	yes	yes	yes	yes	yes	yes
	4-0	yes	yes	yes	yes	yes	yes	yes
	5-0	yes	yes	yes	yes	yes	yes	yes
	6-0	yes	yes	yes	yes	yes	yes	yes
	*7-0	yes	yes	yes	yes	no	no	no

		Fixed Picture Window Width					
		1-0	2-0	3-0	4-0	5-0	6-0
H E I G H T	1-0	yes	yes	yes	yes	yes	yes
	5-0	yes	yes	yes	yes	yes	yes
	6-0	yes	yes	yes	yes	yes	yes
	*7-0	yes	yes	yes	yes	yes	no
	*8-0	yes	yes	yes	yes	no	no

Series 7006 Window Options

Standard Features

- Designed for New Home Construction
- Completely Welded Master Frame
- Vinyl Brick Mould with Integral "J" Channel
- Integral Nailing Fin
- 3/4" Insulated Glass
- Sloped Sill
- Custom Sizes Available
- 3/4" Profiled Grille Bar on GBG Windows
- 2-3/8" Vinyl Jamb
- Available in White and Tan

Options

- Tan Color: Add 10% to List Price
- Obscure Glass: Add \$3.00/sqft of Window Area
- Bronze/Gray Tint Glass: Add \$3.00/sqft of Window Area
- Tempered Glass: Add \$14.04/sqft of Window Area
- Tempered Obscure Glass: Add \$19.75/sqft of Window Area
- Tempered Low-E Glass: Add \$20.70/sqft of Window Area
- 4-9/16" Jamb Extensions Factory Applied: \$64.00
- 4-9/16" Jamb Extensions for Specialty Windows: See Specials Pages
- 6-9/16" Jamb Extensions Factory Applied: \$87.00
- Horizontal Mull: \$58.50
- Vertical Mull: Add \$18.71
- Full Screen
- **Custom grilles (Decralite 1-piece grille): 40% upcharge**
- **Prairie Grilles: 15% upcharge**
- **Prairie (Specialty): 40% upcharge**
- **Gothic Grilles: 40% upcharge**
- **SDLs (Net Pricing):**
 - 7/8" WH = \$6.50/lite
 - 7/8" TN = \$7.00/lite
 - 1-1/4" WH = \$7.00/lite
 - 1-1/4" TN = \$7.50/lite

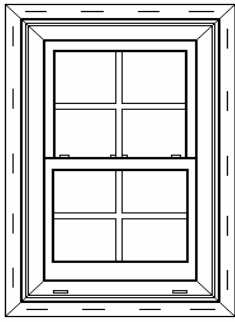

Series 7006 DH

Vinyl Double Hung Windows

- Both Sash Tilt in and Can Be Removed
- 4-9/16" Jamb Extensions: Add \$64.00
- 6-9/16" Jamb Extensions: Add \$87.00

Single Units

Stock Size	1/1	GBG	Lite	Low-E	Screen
2-0 x 3-0	164.50	183.34	4/4	17.52	13.55
2-0 x 3-8	179.02	199.52	4/4	21.41	14.75
2-0 x 4-0	187.79	209.29	4/4	23.36	15.95
2-0 x 4-4	196.50	219.00	4/4	25.31	15.95
2-0 x 5-0	212.23	236.53	4/4	29.20	17.15
2-0 x 5-4	227.09	253.09	6/6	31.24	18.35
2-0 x 6-0	237.17	264.33	6/6	35.04	19.85
2-4 x 3-0	175.43	195.52	6/6	20.44	13.95
2-4 x 3-8	191.03	212.90	6/6	24.98	15.15
2-4 x 4-0	199.68	222.54	6/6	27.25	16.35
2-4 x 4-4	208.62	232.51	6/6	29.52	16.35
2-4 x 5-0	220.04	245.23	6/6	34.07	17.45
2-4 x 5-4	235.44	262.40	9/9	36.45	18.67
2-4 x 6-0	245.85	274.00	9/9	40.88	20.35
2-8 x 3-0	176.95	197.21	6/6	23.36	14.95
2-8 x 3-8	193.04	215.14	6/6	28.55	16.15
2-8 x 4-0	200.32	223.26	6/6	31.15	17.45
2-8 x 4-4	209.07	233.01	6/6	33.74	17.45
2-8 x 5-0	224.82	250.56	6/6	38.93	18.75
2-8 x 5-4	240.56	268.10	9/9	41.66	20.06
2-8 x 6-0	249.88	278.49	9/9	46.72	21.85
3-0 x 3-0	188.84	210.46	6/6	26.28	16.05
3-0 x 3-8	206.29	229.91	6/6	32.12	16.45
3-0 x 4-0	213.03	237.42	6/6	35.04	18.55
3-0 x 4-4	221.99	247.41	6/6	37.96	18.55
3-0 x 5-0	238.14	265.41	6/6	43.80	19.95
3-0 x 5-4	254.81	283.99	6/6	46.72	21.55
3-0 x 6-0	261.85	291.83	9/9	52.56	23.05
3-4 x 3-0	212.10	236.39	8/8	29.20	18.65
3-4 x 3-8	230.00	256.34	8/8	35.69	20.15
3-4 x 4-0	238.14	265.41	8/8	38.93	21.65
3-4 x 4-4	244.28	272.25	8/8	42.18	21.65
3-4 x 5-0	265.39	295.78	8/8	48.67	23.25
3-4 x 5-4	283.97	316.48	12/12	52.07	24.88
3-4 x 6-0	302.38	337.00	12/12	58.40	29.05
3-8 x 3-0	224.06	249.71	8/8	32.12	21.65
3-8 x 3-8	242.83	270.63	8/8	39.26	23.15
3-8 x 4-0	258.98	288.63	8/8	42.83	24.65
3-8 x 4-4	269.91	300.81	8/8	46.40	24.65
3-8 x 5-0	289.72	322.89	8/8	53.53	26.25
3-8 x 5-4	310.00	345.50	12/12	57.28	28.09
3-8 x 6-0	320.88	357.62	12/12	64.24	31.05
Custom Size	Next Larger Size + 59.00			+2.92 per sqft	+33.00

MGM Industries
 287 Freehill Road
 Hendersonville, TN 37075
 Office 1-800-476-5584
 Fax 1-615-822-6581

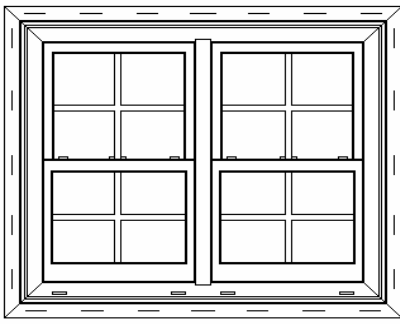

Series 7006 TWIN

Vinyl Double Hung Windows

- Continuous Head and Sill
- Both Sash Tilt in and Can Be Removed
- 4-9/16" Jamb Extensions: Add \$128.00
- 6-9/16" Jamb Extensions: Add \$174.00

Twin Units

Stock Size	1/1	GBG	Lite	Low-E	Screen
2-0 x 3-0	347.71	385.38	4/4	35.04	27.10
2-0 x 3-8	376.75	417.75	4/4	42.83	29.50
2-0 x 4-0	394.29	437.29	4/4	46.72	31.90
2-0 x 4-4	411.71	456.71	4/4	50.61	31.90
2-0 x 5-0	443.17	491.77	4/4	58.40	34.30
2-0 x 5-4	472.88	524.88	6/6	62.49	36.70
2-0 x 6-0	493.05	547.36	6/6	70.08	39.70
2-4 x 3-0	369.57	409.74	6/6	40.88	27.90
2-4 x 3-8	400.77	444.52	6/6	49.96	30.30
2-4 x 4-0	418.07	463.80	6/6	54.51	32.70
2-4 x 4-4	435.95	483.72	6/6	59.05	32.70
2-4 x 5-0	463.79	509.18	6/6	68.13	34.90
2-4 x 5-4	489.60	543.51	9/9	72.90	37.34
2-4 x 6-0	515.41	566.71	9/9	81.76	40.70
2-8 x 3-0	372.61	413.13	6/6	46.72	29.90
2-8 x 3-8	404.79	449.00	6/6	57.10	32.30
2-8 x 4-0	419.35	465.22	6/6	62.29	34.90
2-8 x 4-4	436.85	484.73	6/6	67.48	34.90
2-8 x 5-0	468.35	519.83	6/6	77.87	37.50
2-8 x 5-4	499.82	554.91	9/9	83.32	40.13
2-8 x 6-0	518.47	575.69	9/9	93.44	43.70
3-0 x 3-0	396.39	439.63	6/6	52.56	32.10
3-0 x 3-8	431.29	478.53	6/6	64.24	32.90
3-0 x 4-0	444.77	493.55	6/6	70.08	37.10
3-0 x 4-4	462.69	513.53	6/6	75.92	37.10
3-0 x 5-0	494.99	549.52	6/6	87.60	39.90
3-0 x 5-4	528.33	586.68	6/6	93.44	43.10
3-0 x 6-0	542.41	602.37	9/9	105.12	46.10
3-4 x 3-0	442.91	491.48	8/8	58.40	37.30
3-4 x 3-8	478.71	531.38	8/8	71.38	40.30
3-4 x 4-0	494.99	549.52	8/8	77.87	43.30
3-4 x 4-4	507.27	563.21	8/8	84.36	43.30
3-4 x 5-0	549.49	610.26	8/8	97.33	46.50
3-4 x 5-4	586.64	651.67	12/12	104.15	49.76
3-4 x 6-0	623.47	692.72	12/12	116.80	58.10
3-8 x 3-0	466.83	518.14	8/8	64.24	43.30
3-8 x 3-8	504.37	559.98	8/8	78.52	46.30
3-8 x 4-0	536.67	595.98	8/8	85.65	49.30
3-8 x 4-4	558.53	620.34	8/8	92.79	49.30
3-8 x 5-0	598.15	664.50	8/8	107.07	52.50
3-8 x 5-4	638.71	709.70	12/12	114.56	56.18
3-8 x 6-0	660.47	733.95	12/12	128.48	62.10
Custom Size	Next Larger Size + 108.00			+5.84 per sqft	+66.00

MGM Industries
 287 Freehill Road
 Hendersonville, TN 37075
 Office 1-800-476-5584
 Fax 1-615-822-6581

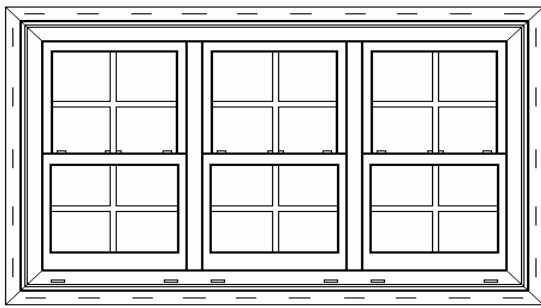

Series 7006 TRIP

Vinyl Double Hung Windows

- Continuous Head and Sill
- Both Sash Tilt in and Can Be Removed
- 4-9/16" Jamb Extensions: Add \$192.00
- 6-9/16" Jamb Extensions: Add \$261.00

Triple Units

Stock Size	1/1	GBG	Lite	Low-E	Screen
2-0 x 3-0	530.92	587.43	4/4	52.56	40.65
2-0 x 3-8	574.48	635.97	4/4	64.24	44.25
2-0 x 4-0	600.79	665.30	4/4	70.08	47.85
2-0 x 4-4	626.92	694.42	4/4	75.92	47.85
2-0 x 5-0	674.11	747.01	4/4	87.60	51.45
2-0 x 5-4	718.68	796.68	6/6	93.73	55.05
2-0 x 6-0	748.93	830.40	6/6	105.12	59.55
2-4 x 3-0	563.71	623.97	6/6	61.32	41.85
2-4 x 3-8	610.51	676.13	6/6	74.95	45.45
2-4 x 4-0	636.46	705.05	6/6	81.76	49.05
2-4 x 4-4	663.28	734.94	6/6	88.57	49.05
2-4 x 5-0	707.54	773.12	6/6	102.20	52.35
2-4 x 5-4	743.75	824.62	9/9	109.35	56.01
2-4 x 6-0	774.97	859.42	9/9	122.64	61.05
2-8 x 3-0	568.27	629.05	6/6	70.08	44.85
2-8 x 3-8	616.54	682.85	6/6	85.65	48.45
2-8 x 4-0	638.38	707.19	6/6	93.44	52.35
2-8 x 4-4	664.63	736.45	6/6	101.23	52.35
2-8 x 5-0	711.88	789.11	6/6	116.80	56.25
2-8 x 5-4	759.09	841.72	9/9	124.98	60.19
2-8 x 6-0	787.06	872.89	9/9	140.16	65.55
3-0 x 3-0	603.94	668.81	6/6	78.84	48.15
3-0 x 3-8	656.29	727.15	6/6	96.36	49.35
3-0 x 4-0	676.51	749.69	6/6	105.12	55.65
3-0 x 4-4	703.39	779.64	6/6	113.88	55.65
3-0 x 5-0	751.84	833.64	6/6	131.40	59.85
3-0 x 5-4	801.85	889.38	6/6	140.16	64.65
3-0 x 6-0	822.97	912.92	9/9	157.68	69.15
Custom Size	Next Larger Size +177.00			+8.76 per sqft	+99.00

MGM Industries
 287 Freehill Road
 Hendersonville, TN 37075
 Office 1-800-476-5584
 Fax 1-615-822-6581

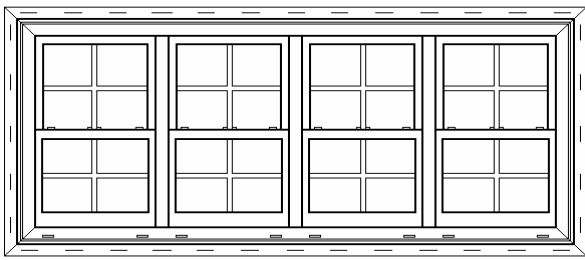

**Series 7006 QUAD
Vinyl Double Hung Windows**

- Continuous Head and Sill
- Both Sash Tilt in and Can Be Removed
- 4-9/16" Jamb Extensions: Add \$256.00
- 6-9/16" Jamb Extensions: Add \$348.00

Quad Units

Stock Size	1/1	GBG	Lite	Low-E	Screen
2-0 x 3-0	714.13	789.47	4/4	70.08	54.20
2-0 x 3-8	772.21	854.20	4/4	85.65	59.00
2-0 x 4-0	807.29	893.30	4/4	93.44	63.80
2-0 x 4-4	842.13	932.13	4/4	101.23	63.80
2-0 x 5-0	905.05	1002.25	4/4	116.80	68.60
2-0 x 5-4	964.47	1068.48	6/6	124.98	73.40
2-0 x 6-0	1004.81	1113.43	6/6	140.16	79.40
2-4 x 3-0	757.85	838.20	6/6	81.76	55.80
2-4 x 3-8	820.25	907.74	6/6	99.93	60.60
2-4 x 4-0	854.85	946.30	6/6	109.01	65.40
2-4 x 4-4	890.61	986.16	6/6	118.10	65.40
2-4 x 5-0	956.29	1037.07	6/6	136.27	69.80
2-4 x 5-4	997.90	1105.73	9/9	145.81	74.69
2-4 x 6-0	1059.53	1152.13	9/9	163.52	81.40
2-8 x 3-0	763.93	844.97	6/6	93.44	59.80
2-8 x 3-8	828.29	916.70	6/6	114.20	64.60
2-8 x 4-0	857.41	949.16	6/6	124.59	69.80
2-8 x 4-4	892.41	988.16	6/6	134.97	69.80
2-8 x 5-0	955.41	1058.38	6/6	155.73	75.00
2-8 x 5-4	1018.36	1128.53	9/9	166.63	80.25
2-8 x 6-0	1055.65	1170.10	9/9	186.88	87.40
Widths Over 2-8 are Shipped as 2 Factory Mull					
↓ Twins With a Precut Field H-Mull ↓					
3-0 x 3-0	811.49	897.98	6/6	105.12	64.20
3-0 x 3-8	881.29	975.77	6/6	128.48	65.80
3-0 x 4-0	908.25	1005.82	6/6	140.16	74.20
3-0 x 4-4	944.09	1045.76	6/6	151.84	74.20
3-0 x 5-0	1008.69	1117.76	6/6	175.20	79.80
3-0 x 5-4	1075.37	1192.07	6/6	186.88	86.20
3-0 x 6-0	1103.53	1223.46	9/9	210.24	92.20
3-4 x 3-0	904.53	1001.67	8/8	116.80	74.60
3-4 x 3-8	976.13	1081.47	8/8	142.76	80.60
3-4 x 4-0	1008.69	1117.76	8/8	155.73	86.60
3-4 x 4-4	1033.25	1145.13	8/8	168.71	86.60
3-4 x 5-0	1117.69	1239.24	8/8	194.67	93.00
3-4 x 5-4	1192.00	1322.06	12/12	208.29	99.51
3-4 x 6-0	1265.65	1404.14	12/12	233.60	116.20
3-8 x 3-0	952.37	1054.99	8/8	128.48	86.60
3-8 x 3-8	1027.45	1138.67	8/8	157.03	92.60
3-8 x 4-0	1092.05	1210.66	8/8	171.31	98.60
3-8 x 4-4	1135.77	1259.39	8/8	185.58	98.60
3-8 x 5-0	1215.01	1347.70	8/8	214.13	105.00
3-8 x 5-4	1296.13	1438.11	12/12	229.12	112.35
3-8 x 6-0	1339.65	1486.61	12/12	256.96	124.20
Custom Size	Next Larger Size + 236.00			+11.68 per sqft	+132.00

MGM Industries
 287 Freehill Road
 Hendersonville, TN 37075
 Office 1-800-476-5584
 Fax 1-615-822-6581

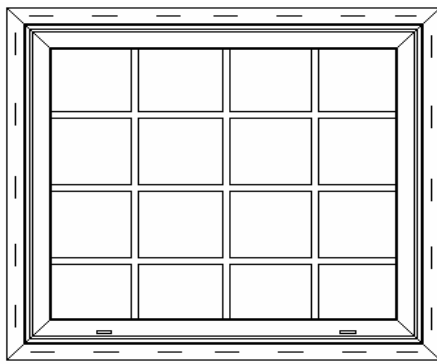

Series 7006 PIC

Vinyl Fixed Picture Windows

- Box Sill
- Custom Sizes Available
- 4-9/16" Jamb Extensions: Add \$64.00
- 6-9/16" Jamb Extensions: Add \$87.00

Fixed Windows

Size	1/1	GBG	Lite	Low-E	Tempered
2-0 x 3-0	163.62	179.16	8	17.52	84.24
2-0 x 3-8	171.09	187.34	8	21.41	102.96
2-0 x 4-0	174.82	191.43	8	23.36	112.32
2-0 x 4-4	178.58	195.55	8	25.31	121.68
2-0 x 5-0	186.05	203.72	8	29.20	140.40
2-0 x 5-4	186.05	203.72	8	31.15	149.76
2-0 x 6-0	200.14	219.15	12	35.04	168.48
2-8 x 3-0	192.46	210.74	12	23.36	112.32
2-8 x 3-8	200.34	219.37	12	28.55	137.28
2-8 x 4-0	208.17	227.95	12	31.15	149.76
2-8 x 4-4	208.17	227.95	12	33.74	162.24
2-8 x 5-0	222.60	243.75	12	38.93	187.20
2-8 x 5-4	222.60	243.75	12	41.53	199.68
2-8 x 6-0	247.48	270.99	18	46.72	224.64
3-0 x 3-0	202.02	221.21	12	26.28	126.36
3-0 x 3-8	215.36	235.82	12	32.12	154.44
3-0 x 4-0	225.98	247.45	12	35.04	168.48
3-0 x 4-4	225.98	247.45	12	37.96	182.52
3-0 x 5-0	276.27	302.52	12	43.80	210.60
3-0 x 5-4	276.27	302.52	12	46.72	224.64
3-0 x 6-0	317.47	347.63	18	52.56	252.72
4-0 x 3-0	234.36	256.62	16	35.04	168.48
4-0 x 3-8	238.29	260.93	16	42.83	205.92
4-0 x 4-0	263.18	288.18	16	46.72	224.64
4-0 x 4-4	263.18	288.18	16	50.61	243.36
4-0 x 5-0	310.34	339.82	16	58.40	280.80
4-0 x 5-4	310.34	339.82	16	62.29	299.52
4-0 x 6-0	366.62	401.45	24	70.08	336.96
5-0 x 3-0	259.25	283.88	20	43.80	210.60
5-0 x 3-8	268.44	293.94	20	53.53	257.40
5-0 x 4-0	311.65	341.26	20	58.40	280.80
5-0 x 4-4	311.65	341.26	20	63.27	304.20
5-0 x 5-0	331.29	362.76	20	73.00	351.00
5-0 x 5-4	331.29	362.76	20	77.87	374.40
5-0 x 6-0	412.44	451.62	30	87.60	421.20
6-0 x 3-0	293.94	321.86	24	52.56	252.72
6-0 x 3-8	304.62	333.56	24	64.24	308.88
6-0 x 4-0	408.51	447.32	24	70.08	336.96
6-0 x 4-4	408.51	447.32	24	75.92	365.04
6-0 x 5-0	417.45	457.11	24	87.60	421.20
6-0 x 5-4	417.45	457.11	24	93.44	449.28
*6-0 x 6-0	484.46	530.48	36	105.12	505.44
Custom Size	Next Larger Size + 59.00			2.92/sqft	14.04/sqft
* Windows with over 30 sqft of glass are required to be tempered					

MGM Industries
 287 Freehill Road
 Hendersonville, TN 37075
 Office 1-800-476-5584
 Fax 1-615-822-6581

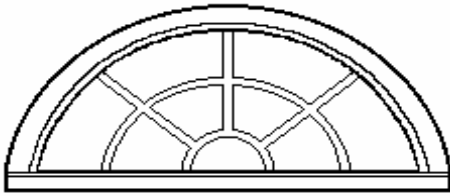

Series 7006 HR

Vinyl Half Round Windows

Size	1-Lite	Low-E	Tempered
2-4	273.02	7.97	38.22
2-8	273.02	10.38	49.92
3-0	273.02	13.14	63.18
3-4	323.61	16.22	78.00
3-8	367.85	19.63	94.38
4-0 (2-0 Twin)	376.86	23.36	112.32
4-8 (2-4 Twin)	385.35	31.80	152.88
5-0 (2-6 Twin)	409.35	36.50	175.50
5-4 (2-8 Twin)	452.69	41.53	199.68
6-0 (3-0 Twin)	495.01	52.56	252.72
6-8 (3-4 Twin)	529.77	64.89	312.00
7-4 (3-8 Twin)*	577.06	78.52	377.52
Custom Size	Next Larger Size + 59.00	2.92/sqft	14.04/sqft

Size	Primed 4-9/16" Jamb Ext.	Primed 6-9/16" Jamb Ext.
2-4	76.93	115.39
2-8	76.93	115.39
3-0	82.06	128.21
3-4	89.75	141.03
3-8	89.75	141.03
4-0 (2-0 Twin)	89.75	141.03
4-8 (2-4 Twin)	102.57	153.85
5-0 (2-6 Twin)	102.57	153.85
5-4 (2-8 Twin)	141.03	179.49
6-0 (3-0 Twin)	141.03	179.49
6-8 (3-4 Twin)	150.20	191.16
7-4 (3-8 Twin)*	150.20	191.16

* Anything over 96" must be two or three pc

** Please specify lettered grille pattern from pages 7-6A or 7-6B when ordering

- **Factory Mull Charge: \$58.50**
- Mull "Prep": \$18.71 (Prepared for job-site mulling)
- Tempered Low-E Glass: Add \$24.85/sqft of Window Area

MGM Industries

287 Freehill Road
 Hendersonville, TN 37075
 Office 1-800-476-5584
 Fax 1-615-822-6581

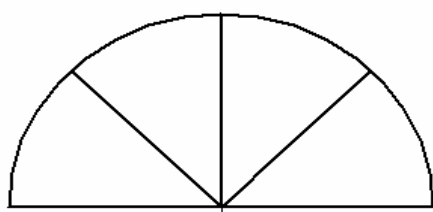

A

3 - Spoke
\$15.60

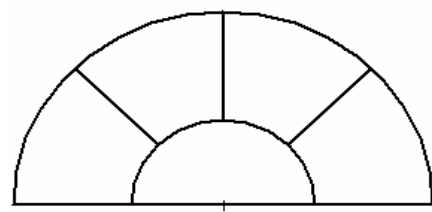

B

3 - Spoke Open Hub
\$24.79

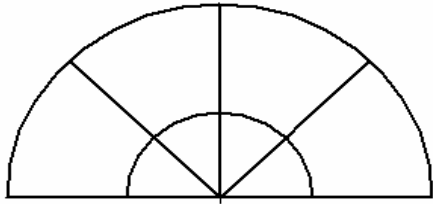

C

3 - Spoke Open Hub Starburst
\$50.04

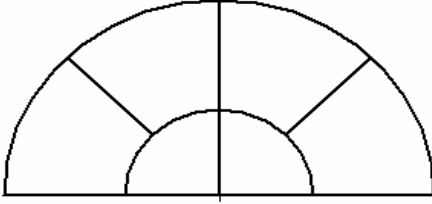

D

3 - Spoke Open Hub Starburst CBO
\$50.04

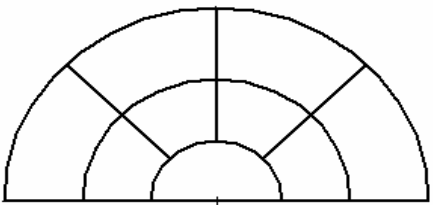

E

3 - Spoke 2-Open Hubs
\$115.95

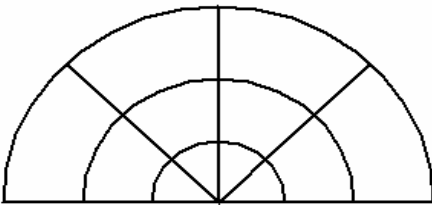

F

3 - Spoke 2-Open Hubs Starburst
\$148.45

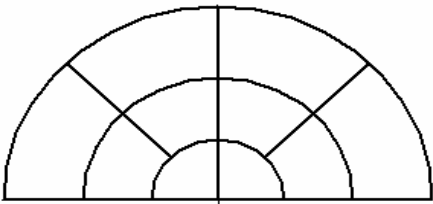

G

3 - Spoke 2-Open Hubs Starburst CBO
\$148.45

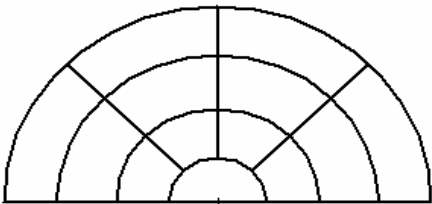

H

3 - Spoke 3-Open Hubs
\$197.20

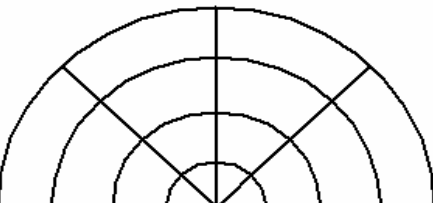

I

3 - Spoke 3-Open Hubs Starburst
\$229.70

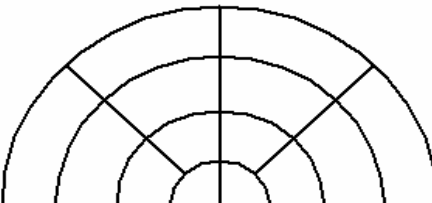

J

3 - Spoke 3-Open Hubs Starburst CBO
\$229.70

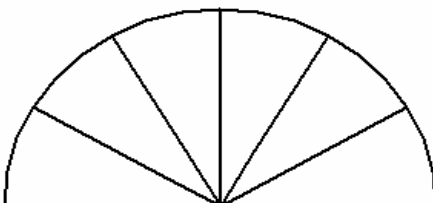

K

5 - Spoke
\$21.19

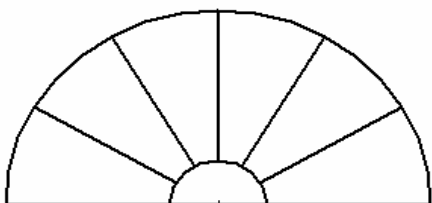

L

5 - Spoke Open Hub
\$36.14

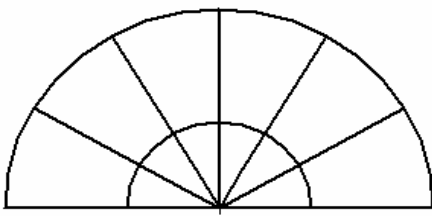

M

5 - Spoke Open Hub Starburst
\$55.64

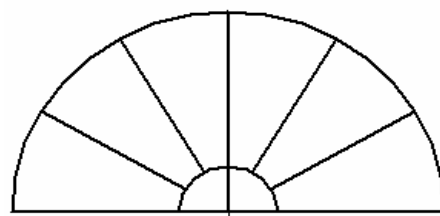

N

5 - Spoke Open Hub Starburst CBO
\$55.64

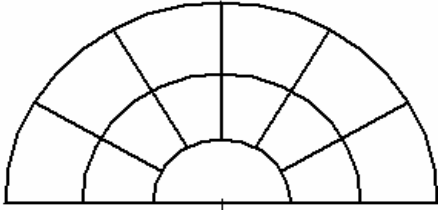

O

5 - Spoke 2-Hub
\$121.54

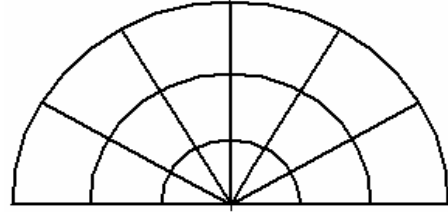

P

5 - Spoke 2-Open Hub Starburst
\$154.04

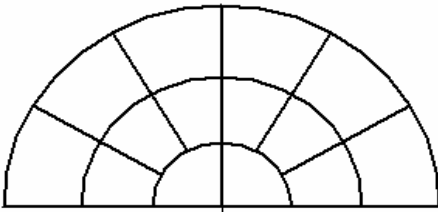

Q

5 - Spoke 2-Open Hub Starburst CBO
\$154.04

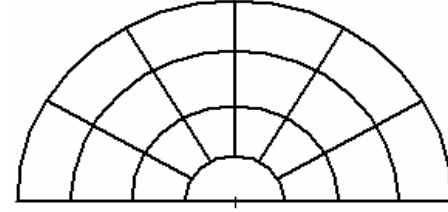

R

5 - Spoke 3-Hub
\$202.79

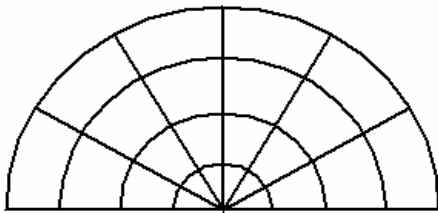

S

5 - Spoke 3-Open Hub Starburst
\$235.29

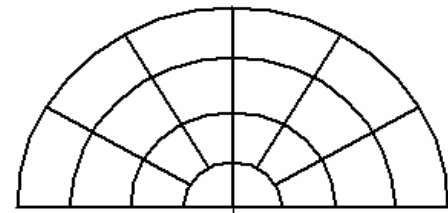

T

5 - Spoke 3-Open Hub Starburst CBO
\$235.29

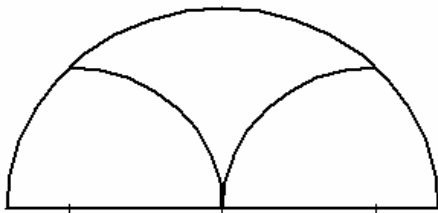

U

1 - Point Gothic

Gothic Patterns
+40% of 1/1 Price

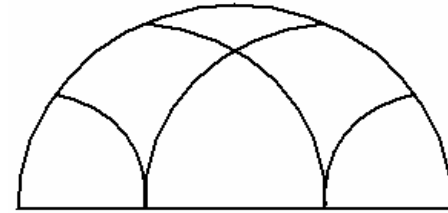

V

2 - Point Gothic

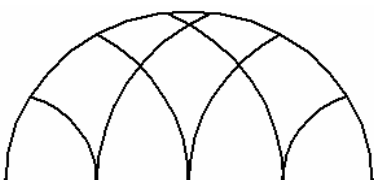

W

3 - Point Gothic

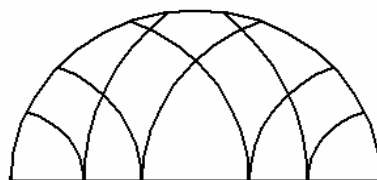

X

4 - Point Gothic

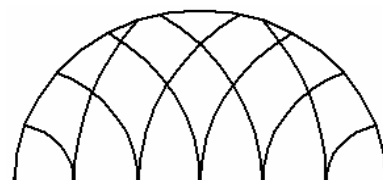

Y

5 - Point Gothic

Note: Gothic Grille Radius will vary somewhat with the width of the Half Round

to check to see if the grille you've picked works in the size Half Round you want

No = Can't use this grille in this size Half Round

NR = Not Recommended due to either appearance or is not architecturally correct but can be built at your risk

Yes = This grille works well in this size Half Round

	Ref Ltr	2-4	2-6	2-8	3-0	3-4	3-8	4-0	2-0TW
3 - Spoke	A	NR	NR	NR	NR	Yes	Yes	Yes	Yes
3 - Spoke Open Hub	B	Yes	Yes	Yes	Yes	Yes	Yes	Yes	Yes
3 - Spoke Open Hub Starburst	C	NR	NR	NR	NR	Yes	Yes	Yes	Yes
3 - Spoke Open Hub Starburst CBO	D	NR	NR	NR	NR	Yes	Yes	Yes	Yes
3 - Spoke 2-Open Hubs	E	No	No	No	No	No	No	No	No
3 - Spoke 2-Open Hubs Starburst	F	No	No	No	No	No	No	No	No
3 - Spoke 2-Open Hubs Starburst CBO	G	No	No	No	No	No	No	No	No
3 - Spoke 3-Open Hubs	H	No	No	No	No	No	No	No	No
3 - Spoke 3-Open Hubs Starburst	I	No	No	No	No	No	No	No	No
3 - Spoke 3-Open Hubs Starburst CBO	J	No	No	No	No	No	No	No	No
5 - Spoke	K	NR	NR	NR	NR	Yes	Yes	Yes	Yes
5 - Spoke Open Hub	L	NR	NR	NR	NR	Yes	Yes	Yes	Yes
5 - Spoke Open Hub Starburst	M	No	No	No	No	Yes	Yes	Yes	Yes
5 - Spoke Open Hub Starburst CBO	N	No	No	No	No	Yes	Yes	Yes	Yes
5 - Spoke 2-Open Hubs	O	No	No	No	No	No	No	No	No
5 - Spoke 2-Open Hubs Starburst	P	No	No	No	No	No	No	No	No
5 - Spoke 2-Open Hubs Starburst CBO	Q	No	No	No	No	No	No	No	No
5 - Spoke 3-Open Hubs	R	No	No	No	No	No	No	No	No
5 - Spoke 3-Open Hubs Starburst	S	No	No	No	No	No	No	No	No
5 - Spoke 3-Open Hubs Starburst CBO	T	No	No	No	No	No	No	No	No
1 - Point Gothic	U	NR	NR	NR	NR	NR	NR	NR	NR
2 - Point Gothic	V	Yes	Yes	Yes	Yes	NR	NR	NR	NR
3 - Point Gothic	W	No	No	No	No	Yes	Yes	Yes	Yes
4 - Point Gothic	X	No	No	No	No	No	No	No	No
5 - Point Gothic	Y	No	No	No	No	No	No	No	No

to check to see if the grille you've picked works in the size Half Round you want

No = Can't use this grille in this size Half Round

NR = Not Recommended due to either appearance or is not architecturally correct but can be built at your risk

Yes = This grille works well in this size Half Round

	Ref Ltr	2-4TW	5-0	2-6TW	103010	2-8TW	6-0	3-0TW	3-4TW	3-8TW
3 - Spoke	A	Yes	NR	Yes	NR	Yes	Yes	Yes	Yes	Yes
3 - Spoke Open Hub	B	Yes	Yes	Yes	Yes	Yes	Yes	Yes	Yes	Yes
3 - Spoke Open Hub Starburst	C	Yes	NR	Yes	NR	Yes	Yes	Yes	Yes	Yes
3 - Spoke Open Hub Starburst CBO	D	Yes	NR	Yes	NR	Yes	Yes	Yes	Yes	Yes
3 - Spoke 2-Open Hubs	E	Yes	Yes	Yes	Yes	Yes	Yes	Yes	Yes	Yes
3 - Spoke 2-Open Hubs Starburst	F	Yes	NR	Yes	NR	Yes	Yes	Yes	Yes	Yes
3 - Spoke 2-Open Hubs Starburst CBO	G	Yes	NR	Yes	NR	Yes	Yes	Yes	Yes	Yes
3 - Spoke 3-Open Hubs	H	No	No	No	No	No	No	No	Yes	Yes
3 - Spoke 3-Open Hubs Starburst	I	No	No	No	No	No	No	No	Yes	Yes
3 - Spoke 3-Open Hubs Starburst CBO	J	No	No	No	No	No	No	No	Yes	Yes
5 - Spoke	K	Yes	Yes	Yes	NR	Yes	Yes	Yes	Yes	Yes
5 - Spoke Open Hub	L	Yes	Yes	Yes	Yes	Yes	Yes	Yes	Yes	Yes
5 - Spoke Open Hub Starburst	M	Yes	NR	Yes	NR	Yes	Yes	Yes	Yes	Yes
5 - Spoke Open Hub Starburst CBO	N	Yes	NR	Yes	NR	Yes	Yes	Yes	Yes	Yes
5 - Spoke 2-Open Hubs	O	Yes	Yes	Yes	Yes	Yes	Yes	Yes	Yes	Yes
5 - Spoke 2-Open Hubs Starburst	P	Yes	NR	Yes	NR	Yes	Yes	Yes	Yes	Yes
5 - Spoke 2-Open Hubs Starburst CBO	Q	Yes	NR	Yes	NR	Yes	Yes	Yes	Yes	Yes
5 - Spoke 3-Open Hubs	R	No	No	No	No	No	No	No	Yes	Yes
5 - Spoke 3-Open Hubs Starburst	S	No	No	No	No	No	No	No	Yes	Yes
5 - Spoke 3-Open Hubs Starburst CBO	T	No	No	No	No	No	No	No	Yes	Yes
1 - Point Gothic	U	NR	NR	NR	No	NR	NR	NR	No	No
2 - Point Gothic	V	NR	NR	NR	No	NR	NR	NR	No	No
3 - Point Gothic	W	NR	NR	NR	No	NR	NR	NR	No	No
4 - Point Gothic	X	NR	Yes	NR	No	NR	NR	NR	No	No
5 - Point Gothic	Y	Yes	No	Yes	No	Yes	Yes	Yes	No	No

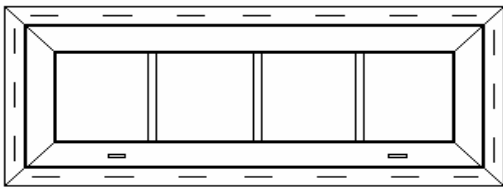

Series 7006 TR

1 Piece Vinyl Fixed Transoms

- Maintenance Free Exterior
- Fully Welded Main Frame
- Mull "Prep": \$18.71 (Prepared for job-site mulling)
- 4-9/16 Jamb Extension: Add \$38.50
- 6-9/16 Jamb Extension: Add \$52.00

- 2 and 3 Piece Factory Mulling Units

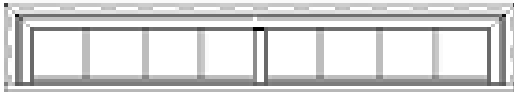

Example: 3/0 Twin x 12" 2-Piece Transom
 Price: \$125.91 + \$125.91 + \$58.50 + \$18.71
 [(3/0 x 12") + (3/0 x 12") + Horizontal Mull
 + Vertical Mull]

Size	1/1	GBG	Low-E	Tempered
1-6 x 12"	94.49	104.51	4.38	21.06
2-0x 12"	94.49	104.51	5.84	28.08
2-4 x 12"	105.00	116.13	6.81	32.76
2-6 x 12"	110.24	121.93	7.30	35.10
2-8 x 12"	115.49	127.73	7.79	37.44
3-0 x 12"	125.91	139.26	8.76	42.12
3-8 x 12"	139.57	154.36	10.71	51.48
4-0 x 12"	142.57	157.68	11.68	56.16
5-0 x 12"	151.59	167.66	14.60	70.20
6-0 x 12"	160.62	177.65	17.52	84.24
1-6 x 14"	108.66	120.18	5.11	24.57
2-0x 14"	108.66	120.18	6.81	32.76
2-4 x 14"	120.75	133.55	7.95	38.22
2-6 x 14"	126.78	140.22	8.52	40.95
2-8 x 14"	132.81	146.89	9.08	43.68
3-0 x 14"	144.80	160.15	10.22	49.14
3-8 x 14"	160.51	177.52	12.49	60.06
4-0 x 14"	163.96	181.34	13.63	65.52
5-0 x 14"	174.33	192.81	17.03	81.90
6-0 x 14"	184.71	204.29	20.44	98.28
Custom Size	Next Larger Size + 59.00		2.92/sqft	14.04/sqft
* Windows with an 96 inch length are required to be tempered				

**** Please specify 2-piece, 3-piece or continuous when ordering**

MGM Industries

287 Freehill Road
 Hendersonville, TN 37075
 Office 1-800-476-5584
 Fax 1-615-822-6581

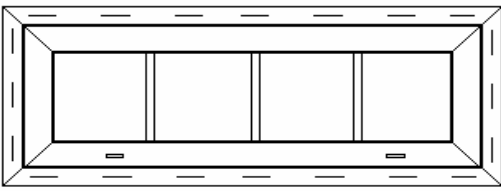

Series 7006 TR

1 Piece Vinyl Fixed Transoms

- Lineal "H" Mull: \$.21/inch
- Mull "Prep": \$18.71 (Prepared for job-site mulling)
- 4 9/16 Jamb Extensions: Add \$38.50
- 6 9/16 Jamb Extensions: \$52.00

- 2 and 3 Piece Factory Mulls Units

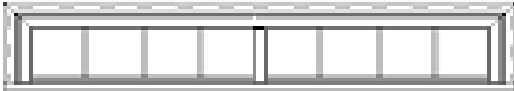

Example: 3/0 Twin x 12" 2-Piece Transom
 Price: \$125.91 + \$125.91 + \$58.50 + \$18.71
 [(3/0 x 12") + (3/0 x 12") + Horizontal Mull
 + Vertical Mull]

**** Please specify 2-piece, 3-piece or continuous when ordering**

Size	1/1	GBG	Low-E	Tempered
2-0 x 18"	130.41	144.23	8.76	42.12
2-4 x 18"	144.89	160.25	10.22	49.14
2-6 x 18"	152.13	168.26	10.95	52.65
2-8 x 18"	159.38	176.27	11.68	56.16
3-0 x 18"	173.76	192.18	13.14	63.18
3-8 x 18"	192.60	213.02	16.06	77.22
4-0 x 18"	196.75	217.61	17.52	84.24
5-0 x 18"	209.20	231.38	21.90	105.30
6-0 x 18"	221.65	245.14	26.28	126.36
2-0x 24"	156.49	173.08	11.68	56.16
2-4 x 24"	173.88	192.31	13.63	65.52
2-6 x 24"	182.56	201.91	14.60	70.20
2-8 x 24"	191.26	211.53	15.57	74.88
3-0 x 24"	208.51	230.61	17.52	84.24
3-8 x 24"	231.12	255.62	21.41	102.96
4-0 x 24"	236.09	261.12	23.36	112.32
5-0 x 24"	251.03	277.64	29.20	140.40
6-0 x 24"	265.98	294.17	35.04	168.48
Custom Size	Next Larger Size + 59.00		2.92/sqft	14.04/sqft

*** Windows with an 96 inch length are required to be tempered**

MGM Industries
 287 Freehill Road
 Hendersonville, TN 37075
 Office 1-800-476-5584
 Fax 1-615-822-6581

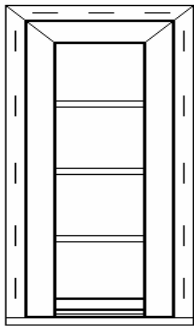

Series 7006 PIC

Vinyl Fixed Flanker Windows

- Maintenance Free Exterior
- Fully Welded Main Frame
- Mull "Prep": \$18.71 (Prepared for job-site mulling)
- 4-9/16 Jamb Extension: Add \$38.50
- 6-9/16 Jamb Extension: Add \$52.00

Stock Sizes	1-Lite	GBG	Lite	Low-E	Tempered
12" x 2-0	137.74	150.83	2	5.84	28.08
12" x 3-0	158.32	173.36	4	8.76	42.12
12" x 3-8	165.47	181.19	4	10.71	51.48
12" x 4-0	169.03	185.14	4	11.68	56.16
12" x 4-4	172.61	189.01	4	12.65	60.84
12" x 5-0	179.77	196.85	4	14.60	70.20
12" x 5-4	184.85	202.41	4	15.57	74.88
12" x 6-0	190.48	208.58	6	17.52	84.24
14" x 2-0	158.40	173.45	2	6.81	32.76
14" x 3-0	182.07	199.37	4	10.22	49.14
14" x 3-8	190.29	208.37	4	12.49	60.06
14" x 4-0	194.38	212.85	4	13.63	65.52
14" x 4-4	198.50	217.36	4	14.76	70.98
14" x 5-0	206.74	226.38	4	17.03	81.90
14" x 5-4	212.58	232.78	4	18.17	87.36
14" x 6-0	219.05	239.86	6	20.44	98.28
Custom Size	Next Larger Size + 59.00			2.92/sqft	14.04/sqft

MGM Industries
 287 Freehill Road
 Hendersonville, TN 37075
 Office 1-800-476-5584
 Fax 1-615-822-6581

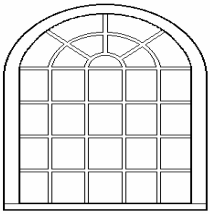

Series 7006 RTPW

Vinyl Round Top Picture Windows

Sizes	RTPW	1-Lite	GBG	Low-E	Tempered	Primed 4-9/16"	Primed 6-9/16"
	Std GBG					Jamb Ext.	Jamb Ext.
2-4 x 4-0	B33	548.00	657.00	31.15	149.76	140.93	179.39
2-4 x 5-0	B34	608.00	730.00	38.93	187.20	140.93	179.39
2-4 x 6-0	B35	698.00	839.00	46.72	224.64	140.93	179.39
2-4 x 7-0	B36	866.00	1040.00	54.51	262.08	140.93	179.39
2-8 x 4-0	B33	548.00	657.00	31.15	149.76	140.93	179.39
2-8 x 5-0	B34	608.00	730.00	38.93	187.20	140.93	179.39
2-8 x 6-0	B35	698.00	839.00	46.72	224.64	140.93	179.39
2-8 x 7-0	B36	866.00	1040.00	54.51	262.08	140.93	179.39
3-0 x 4-0	B33	548.00	657.00	35.04	168.48	146.06	192.21
3-0 x 5-0	B34	608.00	730.00	43.80	210.60	146.06	192.21
3-0 x 6-0	B35	698.00	839.00	52.56	252.72	146.06	192.21
3-0 x 7-0	B36	866.00	1040.00	61.32	294.84	146.06	192.21
3-4 x 4-0	C43	729.00	875.00	38.93	187.20	153.75	205.03
3-4 x 5-0	C44	963.00	1155.00	48.67	234.00	153.75	205.03
3-4 x 6-0	C45	1111.00	1334.00	58.40	280.80	153.75	205.03
3-4 x 7-0	C46	1217.00	1460.00	68.13	327.60	153.75	205.03
4-0 x 4-0	C43	729.00	875.00	46.72	224.64	153.75	205.03
4-0 x 5-0	C44	963.00	1155.00	58.40	280.80	153.75	205.03
4-0 x 6-0	C45	1111.00	1334.00	70.08	336.96	153.75	205.03
*4-0 x 7-0	C46	1217.00	1460.00	81.76	393.12	153.75	205.03
5-0 x 5-0	E53	1142.00	1371.00	73.00	351.00	166.57	217.85
5-0 x 6-0	E54	1295.00	1630.00	87.60	421.20	166.57	217.85
*5-0 x 7-0	E55	1377.00	1720.00	102.20	491.40	166.57	217.85
5-4 x 5-0	E53	1195.00	1529.00	77.87	374.40	205.03	243.49
*5-4 x 6-0	E54	1335.00	1674.00	93.44	449.28	205.03	243.49
*5-4 x 7-0	E55	1412.00	1768.00	109.01	524.16	205.03	243.49
6-0 x 5-0	F62	1284.00	1648.00	87.60	421.20	205.03	243.49
*6-0 x 6-0	F63	1463.00	1829.00	105.12	505.44	205.03	243.49
*6-0 x 7-0	F64	1553.00	1975.00	122.64	589.68	205.03	243.49
All Other Sizes Must Be Quoted							

* Windows with over 30 sqft of glass are required to be tempered

See pages 7006-9A & B for Std RTPW GBG patterns.

All non-standard grille patterns require drawings for quoting and manufacturing

Tempered Low-E Glass: Add \$24.87/sqft of Window Area

MGM Industries

287 Freehill Road
Hendersonville, TN 37075
Office 1-800-476-5584
Fax 1-615-822-6581

Minimum width for A
is 2-4

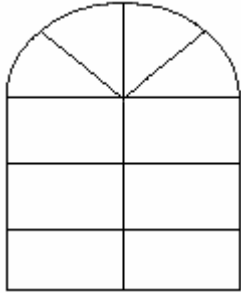

A23

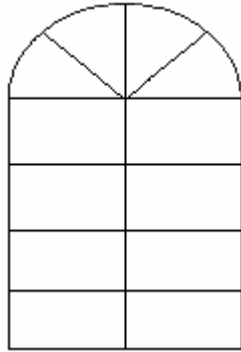

A24

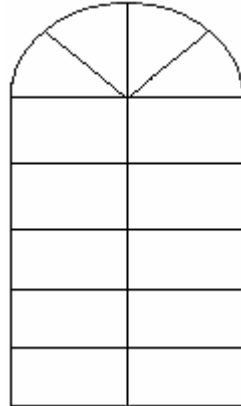

A25

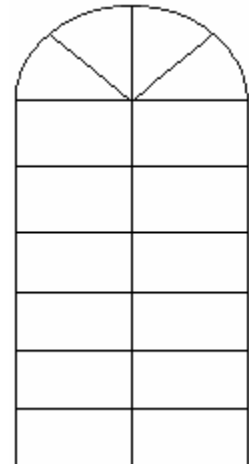

A26

Minimum width for B
is 2-4

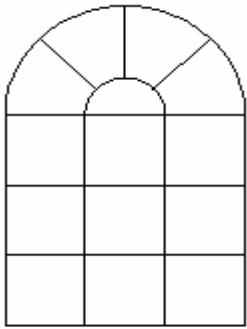

B33

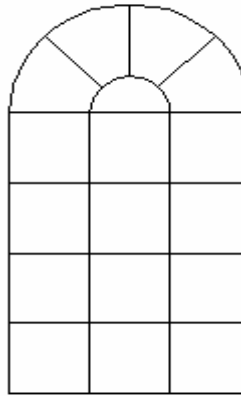

B34

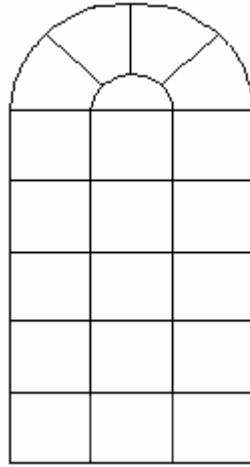

B35

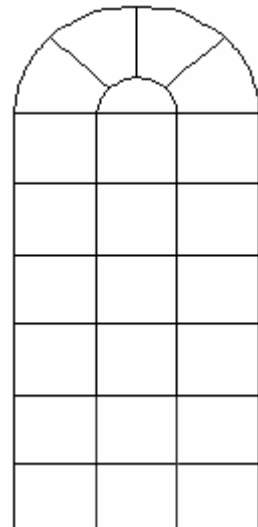

B36

Minimum width for C
is 2-4

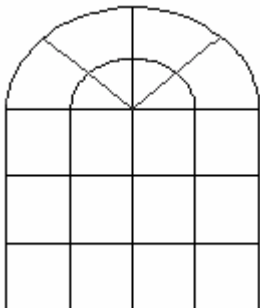

C43

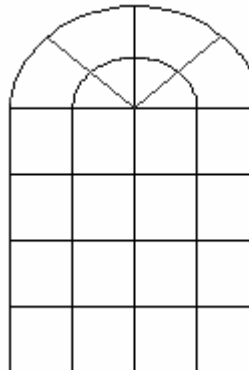

C44

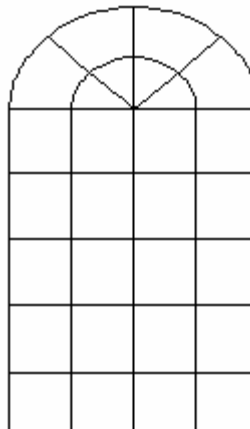

C45

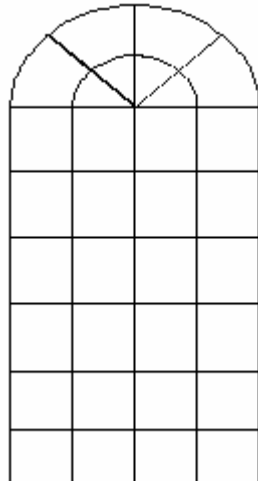

C46

MGM Industries
287 Freehill Road
Hendersonville, TN 37075
Office 1-800-476-5584
Fax 1-615-822-6581

Minimum width for E
is 5-0

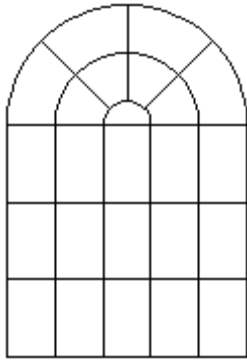

E53

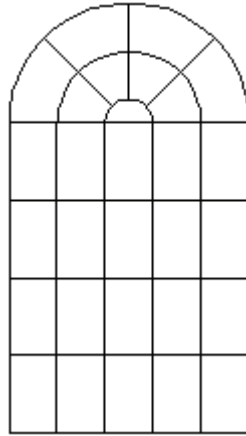

E54

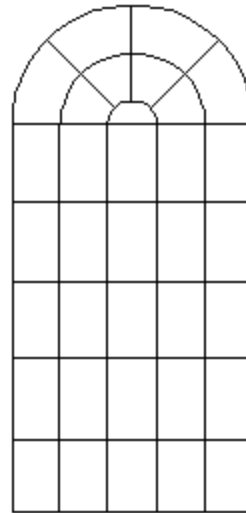

E55

Minimum width for F
is 5-0

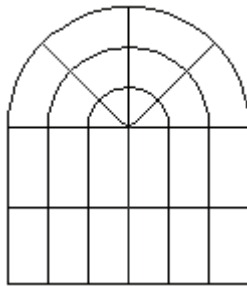

F62

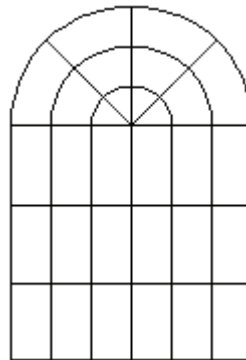

F63

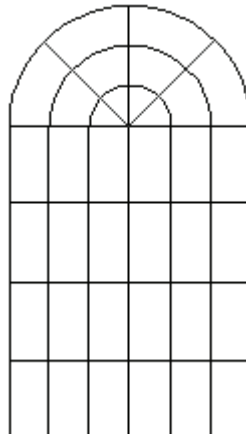

F64

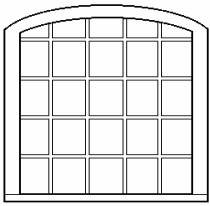

Series 7006 STPW

Vinyl Segment Top Picture Windows

Sizes	1-Lite	GBG	Low-E	Tempered	Primed 4-9/16"	Primed 6-9/16"
					Jamb Ext.	Jamb Ext.
2-4 x 4-0	548.00	657.00	31.15	149.76	140.93	179.39
2-4 x 5-0	608.00	730.00	38.93	187.20	140.93	179.39
2-4 x 6-0	698.00	839.00	46.72	224.64	140.93	179.39
2-4 x 7-0	866.00	1040.00	54.51	262.08	140.93	179.39
2-8 x 4-0	548.00	657.00	31.15	149.76	140.93	179.39
2-8 x 5-0	608.00	730.00	38.93	187.20	140.93	179.39
2-8 x 6-0	698.00	839.00	46.72	224.64	140.93	179.39
2-8 x 7-0	866.00	1040.00	54.51	262.08	140.93	179.39
3-0 x 4-0	548.00	657.00	35.04	168.48	146.06	192.21
3-0 x 5-0	608.00	730.00	43.80	210.60	146.06	192.21
3-0 x 6-0	698.00	839.00	52.56	252.72	146.06	192.21
3-0 x 7-0	866.00	1040.00	61.32	294.84	146.06	192.21
3-4 x 4-0	729.00	875.00	38.93	187.20	153.75	205.03
3-4 x 5-0	963.00	1155.00	48.67	234.00	153.75	205.03
3-4 x 6-0	1111.00	1334.00	58.40	280.80	153.75	205.03
3-4 x 7-0	1217.00	1460.00	68.13	327.60	153.75	205.03
4-0 x 4-0	729.00	875.00	46.72	224.64	153.75	205.03
4-0 x 5-0	963.00	1155.00	58.40	280.80	153.75	205.03
4-0 x 6-0	1111.00	1334.00	70.08	336.96	153.75	205.03
*4-0 x 7-0	1217.00	1460.00	81.76	393.12	153.75	205.03
5-0 x 5-0	1142.00	1371.00	73.00	351.00	166.57	217.85
5-0 x 6-0	1295.00	1630.00	87.60	421.20	166.57	217.85
*5-0 x 7-0	1377.00	1720.00	102.20	491.40	166.57	217.85
5-4 x 5-0	1195.00	1529.00	77.87	374.40	205.03	243.49
*5-4 x 6-0	1335.00	1674.00	93.44	449.28	205.03	243.49
*5-4 x 7-0	1412.00	1768.00	109.01	524.16	205.03	243.49
6-0 x 5-0	1284.00	1648.00	87.60	421.20	205.03	243.49
*6-0 x 6-0	1463.00	1829.00	105.12	505.44	205.03	243.49
*6-0 x 7-0	1553.00	1975.00	122.64	589.68	205.03	243.49
All Other Sizes Must Be Quoted						

* Windows with over 30 sqft of required to be tempered

See pages 7-9A & B for Std RTPW GBG patterns.

All non-standard grille patterns drawings for quoting and manu

Patterns with any arch design (Decralite must be used) are 40% upcharge for STPW

Tempered Low-E Glass: Add \$24.87/sqft of Window Area

MGM Industries
 287 Freehill Road
 Hendersonville, TN 37075
 Office 1-800-476-5584
 Fax 1-615-822-6581

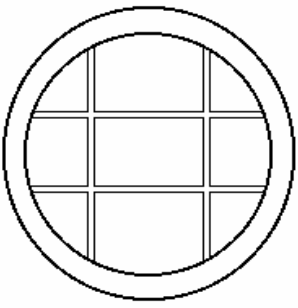

Series 7006 RND

Vinyl Full Round Windows

Diameter	1-Lite	GBG	Low-E	Tempered	Primed 4-9/16"	Primed 6-9/16"
					Jamb Ext.	Jamb Ext.
2-4	564.00	607.00	15.90	76.44	153.86	230.78
2-8	564.00	607.00	20.76	99.84	153.86	230.78
3-0	564.00	607.00	26.28	126.36	164.12	256.42
4-0	630.00	673.00	46.72	224.64	179.50	282.06
5-0	725.00	767.00	73.00	351.00	205.14	307.70
All Other Sizes Must Be Quoted						

- Tempered Low-E Glass: Add \$24.85/sqft of Window Area
- Custom Grill Available with Drawing

*** Series 7006 Full Rounds are Series 5000 Full Rounds
With 1-1/2" Jambs**

MGM Industries

287 Freehill Road
 Hendersonville, TN 37075
 Office 1-800-476-5584
 Fax 1-615-822-6581

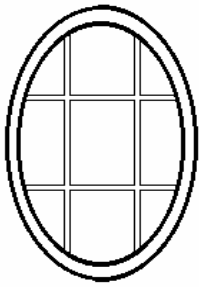

Series 7006 OVAL

Vinyl Fixed Oval Windows

Diameter	1-Lite	GBG	Low-E	Tempered	Primed 4-9/16"	Primed 6-9/16"
					Jamb Ext.	Jamb Ext.
2-0 x 3-0	564.00	625.00	17.52	84.24	153.87	215.40
3-0 x 4-0	630.00	673.00	35.04	168.48	196.95	307.71
All Other Sizes Must Be Quoted						

- Tempered Low-E Glass: Add \$24.85/sqft of Window Area
- Custom Grille Available with Drawing

*** Series 7006 Ovals are Series 5000 Ovals
with 1-1/2" Jambs
Brick Mould and J-Channel on All Oval Units**

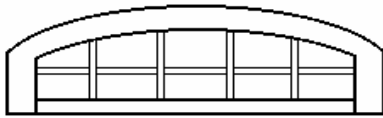

Series 7006 STOP
Vinyl Segment Top Transoms
 (1 Piece)



Example using Decralite Grids

Please Specify Leg and CH When Ordering

Size Width x CH** - Leg	1-Lite	GBG	Low-E	Tempered	Primed	Primed
					4-9/16" Jamb Ext.	6-9/16" Jamb Ext.
2-4 x 12" - 6" Leg	368.00	437.00	6.81	32.76	84.63	126.93
2-6 x 12" - 6" Leg	368.00	437.00	7.30	35.10	84.63	126.93
2-8 x 12" - 6" Leg	368.00	437.00	7.79	37.44	84.63	126.93
3-0 x 12" - 6" Leg	368.00	437.00	8.76	42.12	90.27	141.04
3-4 x 12" - 6" Leg	436.00	514.00	9.73	46.80	98.73	155.14
3-8 x 12" - 6" Leg	436.00	514.00	10.71	51.48	98.73	155.14
4-0 x 12" - 6" Leg	436.00	514.00	11.68	56.16	98.73	155.14
5-0 x 12" - 6" Leg	497.00	578.00	14.60	70.20	112.83	169.24
6-0 x 12" - 6" Leg	564.00	655.92	17.52	84.24	155.14	197.44
6-8 x 12" - 6" Leg	626.67	728.80	19.47	93.60	165.22	210.28
7-0 x 12" - 6" Leg	658.00	765.24	20.44	98.28	165.22	210.28
7-4 x 12" - 6" Leg***	989.33	1101.68	21.43	102.96	165.22	210.28
8-0 x 12" - 6" Leg***	1052.00	1174.56	23.36	112.32	175.30	223.12
9-0 x 12" - 6" Leg***	1146.00	1283.88	26.28	126.36	185.38	235.96
2-4 x 24" - 6" Leg	428.00	511.00	13.63	65.52	86.32	129.47
2-6 x 24" - 6" Leg	428.00	511.00	14.60	70.20	86.32	129.47
2-8 x 24" - 6" Leg	428.00	511.00	15.57	74.88	86.32	129.47
3-0 x 24" - 6" Leg	428.00	511.00	17.52	84.24	92.08	143.86
3-4 x 24" - 6" Leg	531.00	630.00	19.47	93.60	100.70	158.24
3-8 x 24" - 6" Leg	531.00	630.00	21.41	102.96	100.70	158.24
4-0 x 24" - 6" Leg	531.00	630.00	23.36	112.32	100.70	158.24
5-0 x 24" - 6" Leg	597.00	715.00	29.20	140.40	115.09	172.62
6-0 x 24" - 6" Leg	716.40	858.00	35.04	168.48	158.24	201.39
6-8 x 24" - 6" Leg	796.00	953.33	38.94	187.20	168.52	214.49
7-0 x 24" - 6" Leg	835.80	1001.00	40.88	196.56	168.52	214.49
7-4 x 24" - 6" Leg***	1175.60	1348.67	42.86	205.92	168.52	214.49
8-0 x 24" - 6" Leg***	1255.20	1444.00	46.72	224.64	178.81	227.58
9-0 x 24" - 6" Leg***	1374.60	1587.00	52.56	252.72	189.09	240.68
All Other Sizes Must Be Quoted						

* Anything over 96" width or height must be tempered

- Tempered Low-E Glass: Add \$24.85/sqft of Window Area
- **Factory Mull Charge: \$58.50**
- Mull "Prep": \$18.71 (Unit prepared for job-site mulling)
- **Decralite Grilles: Call for Quote**
1 piece grid

- ** CH = Center Height of Unit
- *** **Only available as 3-piece (Includes 3-piece adder in price)**
- 6" Is the Minimum Leg Length Available
- **Two Piece Unit: Add \$150.00**
- **Three Piece Unit: Add \$300.00**

MGM Industries
 287 Freehill Road
 Hendersonville, TN 37075
 Office 1-800-476-5584
 Fax 1-615-822-6581

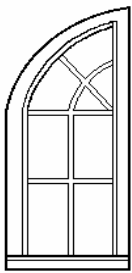

Vinyl Quarter Round Top Picture Windows
Vinyl Gothic Picture Windows
Vinyl Half Segment Windows

Drawing Required on All Orders

Series 7006 QRPW

Base	Height	1-Lite	GBG	Low-E	Tempered	Primed 4-9/16"	Primed 6-9/16"
						Jamb Ext.	Jamb Ext.
16" - 28"	12"	301.00	361.00	2.92/sqft	14.04/sqft	101.85	124.93
	24"	360.00	433.00				
	36"	421.00	505.00				
	48"	482.00	578.00				
	60"	541.00	649.00				
	72"	617.00	741.00				
29" - 36"	12"	368.00	442.00	2.92/sqft	14.04/sqft	109.55	144.16
	24"	428.00	514.00				
	36"	489.00	588.00				
	48"	549.00	659.00				
	60"	609.00	731.00				
	72"	699.00	840.00				
37" - 48"	12"	436.00	524.00	2.92/sqft	14.04/sqft	115.31	153.77
	24"	531.00	637.00				
	36"	632.00	759.00				
	48"	730.00	876.00				
	60"	963.00	1157.00				
	72"	1112.00	1335.00				
49" - 60"	12"	497.00	597.00	2.92/sqft	14.04/sqft	153.77	182.62
	24"	597.00	717.00				
	36"	737.00	885.00				
	48"	978.00	1173.00				
	60"	1143.00	1372.00				

All Other Sizes Must Be Quoted

*** Windows with over 30 sqft of glass are required to be tempered**

- Tempered Low-E Glass: Add \$24.85/sqft of Window Area
- **Factory Mull Charge: \$58.50**
- Mull "Prep": \$18.71 (Unit prepared for job-site mulling)

MGM Industries
 287 Freehill Road
 Hendersonville, TN 37075
 Office 1-800-476-5584
 Fax 1-615-822-6581

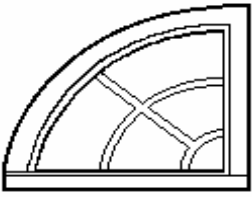

Series 7006 QR
Vinyl Quarter Round Windows

Size	1-Lite	Low-E	Tempered	Primed 4-9/16" Jamb Ext.	Primed 6-9/16" Jamb Ext.
2-4 x 2-4	303.00	15.90	76.44	71.80	102.57
2-8 x 2-8	303.00	20.76	99.84	76.93	115.39
3-0 x 3-0	303.00	26.28	123.36	82.06	128.21
3-4 x 3-4	472.00	32.44	156.00	89.75	141.03
4-0 x 4-0	472.00	46.72	224.64	89.75	141.03
5-0 x 5-0	647.00	73.00	351.00	102.57	153.85
*6-0 x 6-0	875.00	105.12	505.44	141.03	179.49
All Other Sizes Must Be Quoted					
* Standards Require Tempered Glass In This Size					

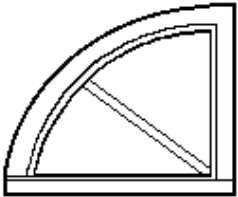

Q1
\$5.00

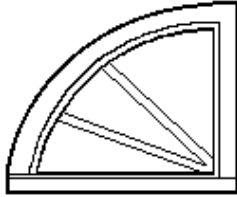

Q2
\$10.00

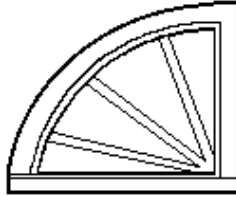

Q3
\$15.00

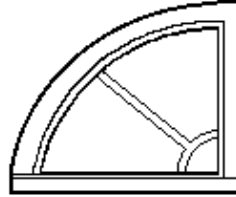

Q4
\$20.00

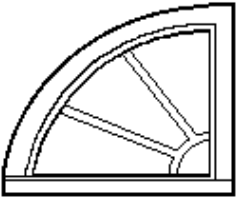

Q5
\$25.00

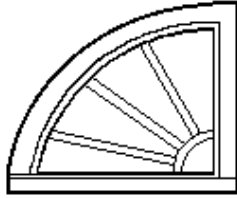

Q6
\$30.00

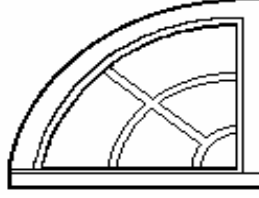

Q7
\$35.00

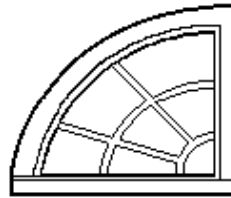

Q8
\$40.00

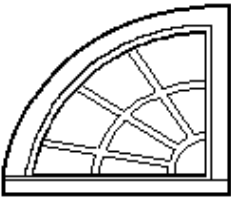

Q9
\$45.00

- Tempered Low-E Glass: Add \$24.85/sqft of Window Area
- **Factory Mull Charge: \$58.50**
- Mull "Prep": \$18.71 (Unit prepared for job-site mulling)
- Lineal "H" Mull: \$.21/inch

*** All Other Patterns Require Drawings for Quoting**

MGM Industries
 287 Freehill Road
 Hendersonville, TN 37075
 Office 1-800-476-5584
 Fax 1-615-822-6581

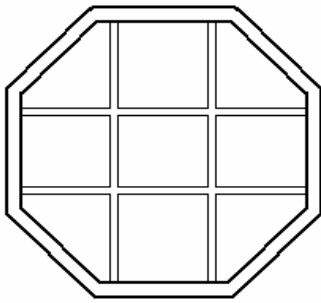

Series 7006 OCT

Vinyl Octagon Windows

Size	1-Lite	GBG	Low-E	Tempered	Primed 4-9/16"	Primed 6-9/16"
					Jamb Ext.	Jamb Ext.
2-0	212.00	259.00	11.68	56.16	64.00	87.00
2-8	314.00	392.00	20.76	99.84	64.00	87.00
3-0	314.00	392.00	26.28	126.36	64.00	87.00
All Other Sizes Must Be Quoted						

*** 1-8 size is no longer available**

- Tempered Low-E Glass: Add \$24.85
of Window Area

MGM Industries
287 Freehill Road
Hendersonville, TN 37075
Office 1-800-476-5584
Fax 1-615-822-6581

Series 7006 TRIA

				Primed 4-9/16"	Primed 6-9/16"
United Inch	1-Lite	Low-E	Tempered	Jamb Ext.	Jamb Ext.
0 - 60	558.00	2.92/sqft	14.04/sqft	192.00	261.00
61 - 84	621.00	2.92/sqft	14.04/sqft	192.00	261.00
85 - 108	684.00	2.92/sqft	14.04/sqft	192.00	261.00
109 - 132	886.00	2.92/sqft	14.04/sqft	192.00	261.00
No Other Sizes Available					

Vinyl Fixed Triangle Windows

- Tempered Low-E Glass: Add \$24.85/sqft of Window Area

- **Factory Mull Charge: \$58.50**

* **Windows with over 30 sqft of glass are required to be tempered**

* United Inch is width + height using the widest and tallest points

Grilles	
2 Lite	12.20/Sash
4 Lite	12.20/Sash
6 Lite	14.60/Sash
8 Lite	16.08/Sash
9 Lite	19.28/Sash
10 Lite	19.28/Sash
16 Lite	46.40/Sash
20 Lite	67.60/Sash

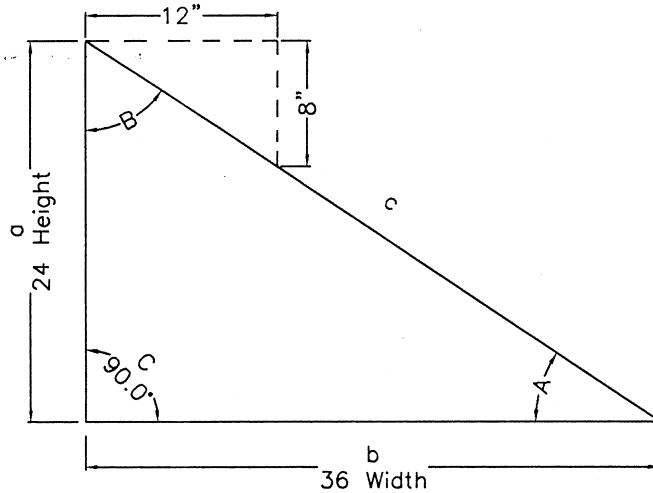

8/12 Roof Pitch
{for every foot(12") of run, the roof drops 8"}

Minimum TanA allowed is .6666 (TanA=a/b)

When Width & Pitch is Given

- 1) Convert 8/12 to TanA.
{ 8/12 = .666(TanA) }
- 2) Multiply Width x TanA
{ 36 x .6666 = 24 }

When Width & Height is Given

- 1) Convert 24/36 to TanA.
{ 24/36 = .6666(TanA) }

When Pitch & Height is Given

- 1) Convert 8/12 to TanA.
{ 8/12 = .6666(TanA) }
- 2) Convert 24/.6666 to Width.
{ 24 / .6666 = 36 }

a + b Not To Exceed 132 United Inches

MGM Industries

287 Freehill Road
Hendersonville, TN 37075
Office 1-800-476-5584
Fax 1-615-822-6581

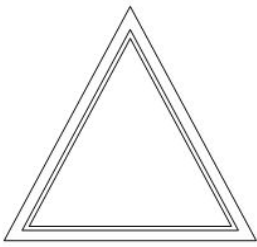

Series 7006 Isosceles Triangle

Vinyl Fixed Triangle Windows

United Inch	1-Lite	Low-E	Tempered	Primed 4-9/16"	Primed 6-9/16"
				Jamb Ext.	Jamb Ext.
0 - 60	558.00	2.92/sqft	14.04/sqft	192.00	261.00
61 - 84	621.00	2.92/sqft	14.04/sqft	192.00	261.00
85 - 108	684.00	2.92/sqft	14.04/sqft	192.00	261.00
109 - 132	886.00	2.92/sqft	14.04/sqft	192.00	261.00
No Other Sizes Available					

* United Inch is width + height using the widest and tallest points

* **Windows with over 30 sqft of glass are required to be tempered**

Grilles	
2 Lite	12.20/Sash
4 Lite	12.20/Sash
6 Lite	14.60/Sash
8 Lite	16.08/Sash
9 Lite	19.28/Sash
10 Lite	19.28/Sash
16 Lite	46.40/Sash
20 Lite	67.60/Sash

- Tempered Low-E Glass: Add \$24.85/sqft of Window Area
- **Factory Mull Charge: \$58.50**

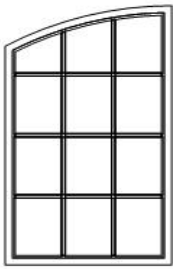

Vinyl Extended Quarter Segment Top Windows
Vinyl Half Segment Windows

Drawing Required on All Orders

Series 7006 Extended Quarter Segment Top

Base	Height	1-Lite	GBG	Low-E	Tempered	Primed 4-9/16" Jamb Ext.	Primed 6-9/16" Jamb Ext.
16" - 28"	12"	301.00	361.00	2.92/sqft	14.04/sqft	101.85	124.93
	24"	360.00	433.00				
	36"	421.00	505.00				
	48"	482.00	578.00				
	60"	541.00	649.00				
	72"	617.00	741.00				
29" - 36"	12"	368.00	442.00	2.92/sqft	14.04/sqft	109.55	144.16
	24"	428.00	514.00				
	36"	489.00	588.00				
	48"	549.00	659.00				
	60"	609.00	731.00				
	72"	699.00	840.00				
37" - 48"	12"	436.00	524.00	2.92/sqft	14.04/sqft	115.31	153.77
	24"	531.00	637.00				
	36"	632.00	759.00				
	48"	730.00	876.00				
	60"	963.00	1157.00				
	72"	1112.00	1335.00				
49" - 60"	12"	497.00	597.00	2.92/sqft	14.04/sqft	153.77	182.62
	24"	597.00	717.00				
	36"	737.00	885.00				
	48"	978.00	1173.00				
	60"	1143.00	1372.00				

All Other Sizes Must Be Quoted

*** Windows with over 30 sqft of glass are required to be tempered**

- Tempered Low-E Glass: Add \$24.85/sqft of Window Area
- **Factory Mull Charge: \$58.50**
- Mull "Prep": \$18.71 (Unit prepared for job-site mulling)

MGM Industries

287 Freehill Road
 Hendersonville, TN 37075
 Office 1-800-476-5584
 Fax 1-615-822-6581

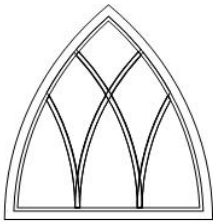

* Shown with Gothic Grilles

**Series 7006 Arch Top
Vinyl Gothic Eyebrow Windows**

Size	1-Lite	GBG	Low-E	Tempered	Primed 4-9/16" Jamb Ext.	Primed 6-9/16" Jamb Ext.
2-0	303.00	424.20	11.68	56.16	64.11	89.75
2-4	303.00	424.20	15.90	76.44	71.80	102.57
2-8	303.00	424.20	20.76	99.84	76.93	115.39
3-0	303.00	424.20	26.28	126.36	82.06	128.21
3-4	472.00	660.80	32.44	156.00	89.75	141.03
4-0	472.00	660.80	46.72	224.64	89.75	141.03
5-0	647.00	905.80	73.00	351.00	102.57	153.85
All Other Sizes Must Be Quoted						

- **Gothic Grilles: 40% upcharge**
- Tempered Low-E Glass: Add \$24.85/sqft
of Window Area
- **Factory Mull Charge: \$58.50**
- Mull "Prep": \$18.71 (Prepared for
job-site mulling)

MGM Industries
287 Freehill Road
Hendersonville, TN 37075
Office 1-800-476-5584
Fax 1-615-822-6581

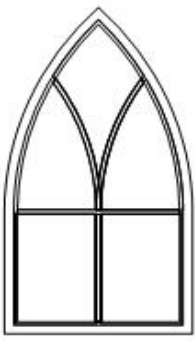

Series 7006 ATPW

Vinyl Arch Top Picture Windows

* Shown with Gothic Grilles

Sizes	1-Lite	GBG	Low-E	Tempered	Primed 4-9/16" Jamb Ext.	Primed 6-9/16" Jamb Ext.
2-0 x 4-0	548.00	657.00	23.36	112.32	135.80	166.57
2-0 x 5-0	608.00	730.00	29.20	140.40	135.80	166.57
2-0 x 6-0	698.00	839.00	35.04	168.48	135.80	166.57
2-0 x 7-0	866.00	1040.00	40.88	196.56	135.80	166.57
2-4 x 4-0	548.00	657.00	27.26	131.04	135.80	166.57
2-4 x 5-0	608.00	730.00	34.07	163.80	135.80	166.57
2-4 x 6-0	698.00	839.00	40.88	196.56	135.80	166.57
2-4 x 7-0	866.00	1040.00	47.70	229.32	135.80	166.57
2-8 x 4-0	548.00	657.00	31.15	149.76	135.80	166.57
2-8 x 5-0	608.00	730.00	38.93	187.20	135.80	166.57
2-8 x 6-0	698.00	839.00	46.72	224.64	135.80	166.57
2-8 x 7-0	866.00	1040.00	54.51	262.08	135.80	166.57
3-0 x 4-0	548.00	657.00	35.04	168.48	146.06	192.21
3-0 x 5-0	608.00	730.00	43.80	210.60	146.06	192.21
3-0 x 6-0	698.00	839.00	52.56	252.72	146.06	192.21
3-0 x 7-0	866.00	1040.00	61.32	294.84	146.06	192.21
3-4 x 4-0	729.00	875.00	38.93	187.20	153.75	205.03
3-4 x 5-0	963.00	1155.00	48.67	234.00	153.75	205.03
3-4 x 6-0	1111.00	1334.00	58.40	280.80	153.75	205.03
3-4 x 7-0	1217.00	1460.00	68.13	327.60	153.75	205.03
4-0 x 4-0	729.00	875.00	46.72	224.64	153.75	205.03
4-0 x 5-0	963.00	1155.00	58.40	280.80	153.75	205.03
4-0 x 6-0	1111.00	1334.00	70.08	336.96	153.75	205.03
*4-0 x 7-0	1217.00	1460.00	81.76	393.12	153.75	205.03
5-0 x 5-0	1142.00	1371.00	73.00	351.00	166.57	217.85
5-0 x 6-0	1295.00	1630.00	87.60	421.20	166.57	217.85
*5-0 x 7-0	1377.00	1720.00	102.20	491.40	166.57	217.85
5-4 x 5-0	1195.00	1529.00	77.87	374.40	205.03	243.49
*5-4 x 6-0	1335.00	1674.00	93.44	449.28	205.03	243.49
*5-4 x 7-0	1412.00	1768.00	109.01	524.16	205.03	243.49
6-0 x 5-0	1284.00	1648.00	87.60	421.20	205.03	243.49
*6-0 x 6-0	1463.00	1829.00	105.12	505.44	205.03	243.49
*6-0 x 7-0	1553.00	1975.00	122.64	589.68	205.03	243.49
All Other Sizes Must Be Quoted						

* Windows with over 30 sqft of glass are required to be tempered - Patterns with any arch design (Decralite must be used) are 40% upcharge for ATPW

All non-standard grille patterns require drawings for quoting and manufacturing - Tempered Low-E Glass: Add \$24.85/sqft of Window Area

MGM Industries
 287 Freehill Road
 Hendersonville, TN 37075
 Office 1-800-476-5584
 Fax 1-615-822-6581

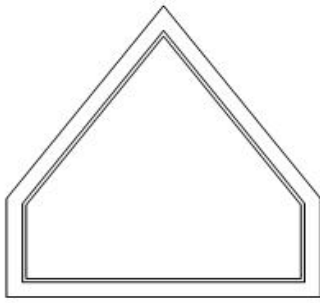

Series 7006 Pentagon

United Incl	1-Lite	Low-E	Tempered	Primed 4-9/16"	Primed 6-9/16"
				Jamb Ext.	Jamb Ext.
0 - 60	558.00	2.92/sqft	14.04/sqft	320.00	435.00
61 - 84	621.00	2.92/sqft	14.04/sqft	320.00	435.00
85 - 108	684.00	2.92/sqft	14.04/sqft	320.00	435.00
109 - 132	886.00	2.92/sqft	14.04/sqft	320.00	435.00
All Other Sizes Must Be Quoted					

*** Drawings Are Required On All Orders**

* United Inch is width + height using the widest and tallest points

*** Windows with over 30 sqft of glass are required to be tempered**

Grilles	
2 Lite	12.20/Sash
4 Lite	12.20/Sash
6 Lite	14.60/Sash
8 Lite	16.08/Sash
9 Lite	19.28/Sash
10 Lite	19.28/Sash
16 Lite	46.40/Sash
20 Lite	67.60/Sash

- Tempered Low-E Glass: Add \$24.85/sqft of Window Area

MGM Industries

287 Freehill Road

Hendersonville, TN 37075

Office 1-800-476-5584

Fax 1-615-822-6581

2/2/07 7006-22

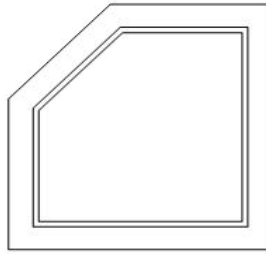
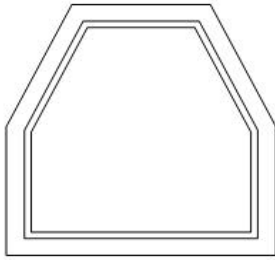
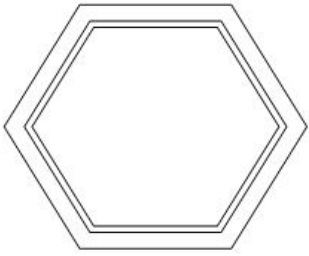

Series 7006 Hexagon

Series 7006 Hex Head

Series 7006 Half Hex Head

Size	1-Lite	GBG	Low-E	Tempered	Primed 4-9/16"	Primed 6-9/16"
					Jamb Ext.	Jamb Ext.
1-8	265.00	293.75	8.11	39.00	384.00	522.00
2-0	265.00	293.75	11.68	56.16	384.00	522.00
2-8	392.50	445.00	20.76	99.84	384.00	522.00
3-0	392.50	445.00	26.28	126.36	384.00	522.00
All Other Sizes Must Be Quoted						

*** Drawings Are Required On All Orders**

- Tempered Low-E Glass: Add \$24.85/sqft
of Window Area

MGM Industries

287 Freehill Road

Hendersonville, TN 37075

Office 1-800-476-5584

Fax 1-615-822-6581

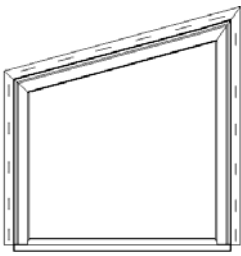

Series 7006 TRAP

Vinyl Fixed Trapezoid Windows

- Tempered Low-E Glass: Add \$24.85/sqft of Window Area

* **Windows with over 30 sqft of glass are required to be tempered**

United Inch	1-Lite	Low-E	Tempered	Primed	Primed
				4-9/16" Jamb Ext.	6-9/16" Jamb Ext.
0 - 60	558.00	2.92/sqft	14.04/sqft	256.00	348.00
61 - 84	621.00	2.92/sqft	14.04/sqft	256.00	348.00
85 - 108	684.00	2.92/sqft	14.04/sqft	256.00	348.00
109 - 132	886.00	2.92/sqft	14.04/sqft	256.00	348.00
No Other Sizes Available					

Grilles	
2 Lite	12.20/Sash
4 Lite	12.20/Sash
6 Lite	14.60/Sash
8 Lite	16.08/Sash
9 Lite	19.28/Sash
10 Lite	19.28/Sash
16 Lite	46.40/Sash
20 Lite	67.60/Sash

* United Inch is width + height using the widest and tallest points

Example:

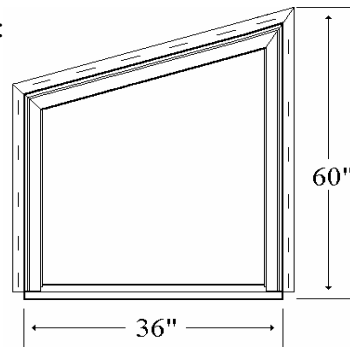

$36" + 60" = 96$ United Inches

A, B and C Measurements Required
(As Viewed From Outside)

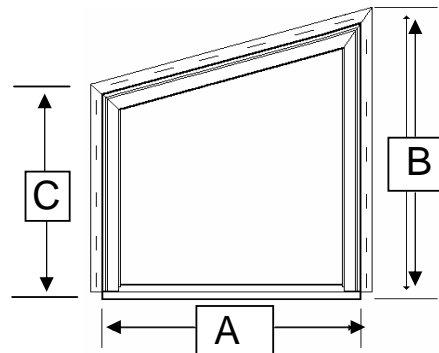

Maximum B Measurement is 9 feet
 Minimum C Measurement is 6 inches
A + B Not To Exceed 132 United Inches

Series 7006 Vinyl Double Hung Rough Opening Chart

Size	Single	Twin	Triple	Quad
2-0 x 3-0	24" x 36"	47-1/4" x 36"	70-1/2" x 36"	93-3/4" x 36"
3-8	24" x 44"	47-1/4" x 44"	70-1/2" x 44"	93-3/4" x 44"
4-0	24" x 48"	47-1/4" x 48"	70-1/2" x 48"	93-3/4" x 48"
4-4	24" x 52"	47-1/4" x 52"	70-1/2" x 52"	93-3/4" x 52"
5-0	24" x 60"	47-1/4" x 60"	70-1/2" x 60"	93-3/4" x 60"
6-0	24" x 72"	47-1/4" x 72"	70-1/2" x 72"	93-3/4" x 72"
2-4 x 3-0	28" x 36"	55-1/4" x 36"	82-1/2" x 36"	109-3/4" x 36"
3-8	28" x 44"	55-1/4" x 44"	82-1/2" x 44"	109-3/4" x 44"
4-0	28" x 48"	55-1/4" x 48"	82-1/2" x 48"	109-3/4" x 48"
4-4	28" x 52"	55-1/4" x 52"	82-1/2" x 52"	109-3/4" x 52"
5-0	28" x 60"	55-1/4" x 60"	82-1/2" x 60"	109-3/4" x 60"
6-0	28" x 72"	55-1/4" x 72"	82-1/2" x 72"	109-3/4" x 72"
2-6 x 3-0	30" x 36"	59-1/4" x 36"	88-1/2" x 36"	117-3/4" x 36"
3-8	30" x 44"	59-1/4" x 44"	88-1/2" x 44"	117-3/4" x 44"
4-0	30" x 48"	59-1/4" x 48"	88-1/2" x 48"	117-3/4" x 48"
4-4	30" x 52"	59-1/4" x 52"	88-1/2" x 52"	117-3/4" x 52"
5-0	30" x 60"	59-1/4" x 60"	88-1/2" x 60"	117-3/4" x 60"
6-0	30" x 72"	59-1/4" x 72"	88-1/2" x 72"	117-3/4" x 72"
2-8 x 3-0	32" x 36"	63-1/4" x 36"	94-1/2" x 36"	125-3/4" x 36"
3-8	32" x 44"	63-1/4" x 44"	94-1/2" x 44"	125-3/4" x 44"
4-0	32" x 48"	63-1/4" x 48"	94-1/2" x 48"	125-3/4" x 48"
4-4	32" x 52"	63-1/4" x 52"	94-1/2" x 52"	125-3/4" x 52"
5-0	32" x 60"	63-1/4" x 60"	94-1/2" x 60"	125-3/4" x 60"
6-0	32" x 72"	63-1/4" x 72"	94-1/2" x 72"	125-3/4" x 72"
3-0 x 3-0	36" x 36"	71-1/4" x 36"	106-1/2" x 36"	141-7/8" x 36"
3-8	36" x 44"	71-1/4" x 44"	106-1/2" x 44"	141-7/8" x 44"
4-0	36" x 48"	71-1/4" x 48"	106-1/2" x 48"	141-7/8" x 48"
4-4	36" x 52"	71-1/4" x 52"	106-1/2" x 52"	141-7/8" x 52"
5-0	36" x 60"	71-1/4" x 60"	106-1/2" x 60"	141-7/8" x 60"
5-4	36" x 64"	71-1/4" x 64"	106-1/2" x 64"	141-7/8" x 64"
6-0	36" x 72"	71-1/4" x 72"	106-1/2" x 72"	141-7/8" x 72"
3-4 x 3-0	40" x 36"	79-1/4" x 36"	N/A	157-7/8" x 36"
3-8	40" x 44"	79-1/4" x 44"	N/A	157-7/8" x 44"
4-0	40" x 48"	79-1/4" x 48"	N/A	157-7/8" x 48"
4-4	40" x 52"	79-1/4" x 52"	N/A	157-7/8" x 52"
5-0	40" x 60"	79-1/4" x 60"	N/A	157-7/8" x 60"
6-0	40" x 72"	79-1/4" x 72"	N/A	157-7/8" x 72"
3-8 x 3-0	44" x 36"	87-1/4" x 36"	N/A	173-7/8" x 36"
3-8	44" x 44"	87-1/4" x 44"	N/A	173-7/8" x 44"
4-0	44" x 48"	87-1/4" x 48"	N/A	173-7/8" x 48"
4-4	44" x 52"	87-1/4" x 52"	N/A	173-7/8" x 52"
5-0	44" x 60"	87-1/4" x 60"	N/A	173-7/8" x 60"
6-0	44" x 72"	87-1/4" x 72"	N/A	173-7/8" x 72"

Widths Over 2-8 are Shipped as 2 Factory Muller Twins With a Precut Field H-Mull

Series 7006 Vinyl Half Round, Transom and Picture Window Rough Opening Chart

Size	Half Round Add to R/O
2-4	13-5/8"
2-6	14-5/8"
2-8	15-5/8"
3-0	17-5/8"
3-4	19-5/8"
3-8	21-5/8"
4-0	23-5/8"
2-0 Twin	23-3/8"
2-4 Twin	27-3/8"
5-0	29-5/8"
2-6 Twin	29-3/8"
1-0 x 3-0 x 1-0	28-7/8"
2-8 Twin	31-3/8"
6-0	35-5/8"
3-0 Twin	35-3/8"
3-4 Twin	39-3/8"
3-8 Twin	44-3/8"

Rectangular Transom	
12"	add 11-1/4"
14"	add 13-1/4"

Segment Transom	
12"	add 11-1/4"
24"	add 23-1/4"

Picture Window	Rough Opening
2-0 x 3-0	24" x 36"
2-0 x 3-8	24" x 44"
2-0 x 4-0	24" x 48"
2-0 x 4-4	24" x 52"
2-0 x 5-0	24" x 60"
2-0 x 5-4	24" x 64"
2-0 x 6-0	24" x 72"
2-8 x 3-0	32" x 36"
2-8 x 3-8	32" x 44"
2-8 x 4-0	32" x 48"
2-8 x 4-4	32" x 52"
2-8 x 5-0	32" x 60"
2-8 x 5-4	32" x 64"
2-8 x 6-0	32" x 72"
3-0 x 3-0	36" x 36"
3-0 x 3-8	36" x 44"
3-0 x 4-0	36" x 48"
3-0 x 4-4	36" x 52"
3-0 x 5-0	36" x 60"
3-0 x 5-4	36" x 64"
3-0 x 6-0	36" x 72"
4-0 x 3-0	48" x 36"
4-0 x 3-8	48" x 44"
4-0 x 4-0	48" x 48"
4-0 x 4-4	48" x 52"
4-0 x 5-0	48" x 60"
4-0 x 5-4	48" x 64"
4-0 x 6-0	48" x 72"
5-0 x 3-0	60" x 36"
5-0 x 3-8	60" x 44"
5-0 x 4-0	60" x 48"
5-0 x 4-4	60" x 52"
5-0 x 5-0	60" x 60"
5-0 x 5-4	60" x 64"
5-0 x 6-0	60" x 72"
6-0 x 3-0	72" x 36"
6-0 x 3-8	72" x 44"
6-0 x 4-0	72" x 48"
6-0 x 4-4	72" x 52"
6-0 x 5-0	72" x 60"
6-0 x 5-4	72" x 64"
6-0 x 6-0	72" x 72"

MGM Industries

287 Freehill Road

Hendersonville, TN 37075

Office 1-800-476-5584

Fax 1-615-822-6581

Series 7006 Double Hung Windows

WIDTH

Egress		Call-Out	2/0	2/4	2/6	2/8	3/0	3/4	3/6	3/8	4/0
		E.W.D.	24.25	28.25	30.25	32.25	36.25	40.25	42.25	44.25	48.25
Call-Out	E.W.D.	Opening	19.598	23.598	25.598	27.598	31.598	35.598	37.598	39.598	43.598
3/0	36	11.8125	1.6	1.9	2.1	2.3	2.6	2.9	3.1	3.2	3.6
3/2	38	12.8125	1.7	2.1	2.3	2.5	2.8	3.2	3.3	3.5	3.9
3/4	40	13.8125	1.9	2.3	2.5	2.6	3.0	3.4	3.6	3.8	4.2
3/6	42	14.8125	2.0	2.4	2.6	2.8	3.3	3.7	3.9	4.1	4.5
3/8	44	15.8125	2.2	2.6	2.8	3.0	3.5	3.9	4.1	4.3	4.8

H E I G H T	4/0	48	17.8125	2.4	2.9	3.2	3.4	3.9	4.4	4.7	4.9	5.4
	4/2	50	18.8125	2.6	3.1	3.3	3.6	4.1	4.7	4.9	5.2	5.7
	4/4	52	19.8125	2.7	3.2	3.5	3.8	4.3	4.9	5.2	5.4	6.0
	4/6	54	20.8125	2.8	3.4	3.7	4.0	4.6	5.1	5.4	5.7	6.3
	4/8	56	21.8125	3.0	3.6	3.9	4.2	4.8	5.4	5.7	6.0	6.6

5/0	60	23.8125	3.2	3.9	4.2	4.6	5.2	5.9	6.2	6.5	7.2
5/2	62	24.8125	3.4	4.1	4.4	4.8	5.4	6.1	6.5	6.8	7.5
5/4	64	25.8125	3.5	4.2	4.6	4.9	5.7	6.4	6.7	7.1	7.8
5/6	66	26.8125	3.6	4.4	4.8	5.1	5.9	6.6	7.0	7.4	8.1
5/8	68	27.8125	3.8	4.6	4.9	5.3	6.1	6.9	7.3	7.6	8.4

6/0	72	29.8125	4.1	4.9	5.3	5.7	6.5	7.4	7.8	8.2	9.0
6/2	74	30.8125	4.2	5.0	5.5	5.9	6.8	7.6	8.0	8.5	9.3

E.W.D. = Exterior Window Dimension
DLO = Day Light Opening.

WIDTH

DLO TOP		Call-Out	2/0	2/4	2/6	2/8	3/0	3/4	3/6	3/8	4/0
		E.W.D.	24.25	28.25	30.25	32.25	36.25	40.25	42.25	44.25	48.25
Call-Out	E.W.D.	Opening	18.500	22.500	24.500	26.500	30.500	34.500	36.500	38.500	42.500
3/0	36	13	1.8	2.1	2.3	2.5	2.9	3.2	3.4	3.6	3.9
4/0	48	19	2.6	3.1	3.4	3.6	4.2	4.7	5.0	5.2	5.8
5/0	60	25	3.4	4.1	4.4	4.8	5.5	6.2	6.5	6.9	7.6
6/0	72	31	4.2	5.1	5.5	5.9	6.8	7.7	8.1	8.5	9.4

**H
E
I
G
H
T**

DLO BOTTOM.		Call-Out	2/0	2/4	2/6	2/8	3/0	3/4	3/6	3/8	4/0
		E.W.D.	24.3	28.3	30.3	32.3	36.3	40.3	42.3	44.3	48.3
Call-Out	E.W.D.	Opening	19.5	23.5	25.5	27.5	31.5	35.5	37.5	39.5	43.5
3/0	36	13	1.8	2.1	2.3	2.5	2.9	3.2	3.4	3.6	3.9
4/0	48	19	2.6	3.1	3.4	3.6	4.2	4.7	5.0	5.2	5.8
5/0	60	25	3.4	4.1	4.4	4.8	5.5	6.2	6.5	6.9	7.6
6/0	72	31	4.2	5.1	5.5	5.9	6.8	7.7	8.1	8.5	9.4

MGM Industries

287 Freehill Road
Hendersonville, TN 37075
Office 1-800-476-5584
Fax 615-822-6581