

# Series 6000 Vinyl Single Hung Windows

Visit [MGMIindustries.com](http://MGMIindustries.com) for a complete online catalog

## Page

1	Singles
2	Twins
3	Triples
4	Quads
5	Fixed Pictures
6	Half Rounds
7	Transoms
8	Flankers
9	Round Top Pictures
10	Segment Top Pictures
11	Full Rounds
12	Ovals
13	One Piece Segment Top Transoms
14	Quarter Top, Gothic, and Half Segment Pictures
15	Quarter Rounds
16	Octagons
17	Triangle
18	Isosceles Triangle
19	2-Lite Sliders
20	3-Lite Sliders
21	Extended Quarter Segment Top
22	Arch Top
23	Arch Top Picture
24	Hexagon, Hex Head, and Half Hex Head
25	Pentagon
26	Trapezoid
27	Rough Opening Chart 1
28	Rough Opening Chart 2
29	Slider Window Egress & Daylight Opening Chart
30	Single Hung Window Egress & Daylight Opening Chart
31	Single Hung, Transom, 2-Lite Slider, Fixed Picture and

## Series 6000 Product Information

<u>Test</u>	<u>Result</u>
- Air Infiltration	0.18 cfm/sq.ft.
- Water Resistance at 5 gph/sq.ft.	No Leakage
- Max. Water Pressure Achieved	7.5 PSF (Grade 50)
- Design Pressure	30 PSF
- Max. Structural Pressure Achieved	45 PSF
- Overall Rating	H-R30-36x62
- R Value Standard Clear Glass	2.33*
- U Value Standard Clear Glass	0.43
- R Value Low-E Glass	2.86
- U Value Low-E Glass	0.35

\* Complete operating unit tested

### Minimum and Maximum Build Size

		Single Hung Window Width							
		1-6	2-0	2-4	3-0	3-4	3-8	4-0	
HEIGHT	E	2-9	yes	yes	yes	yes	yes	yes	yes
	I	4-0	yes	yes	yes	yes	yes	yes	yes
	G	5-0	yes	yes	yes	yes	yes	yes	yes
	H	6-0	yes	yes	yes	yes	yes	yes	yes
	T	*7-0	yes	yes	yes	yes	no	no	no

		Fixed Picture Window Width						
		1-0	2-0	3-0	4-0	5-0	6-0	
HEIGHT	E	1-0	yes	yes	yes	yes	yes	yes
	I	5-0	yes	yes	yes	yes	yes	yes
	G	6-0	yes	yes	yes	yes	yes	yes
	H	*7-0	yes	yes	yes	yes	yes	no
	T	*8-0	yes	yes	yes	yes	no	no

		2-Lite or 3-Lite Slider Window Width						3-Lite Slider Only*		
		2-8	3-0	3-4	4-0	5-0	6-0	7-0	8-0	9-0
HEIGHT	E	1-8	yes	yes	yes	yes	yes	yes	yes	yes
	I	3-0	yes	yes	yes	yes	yes	yes	yes	yes
	G	4-0	yes	yes	yes	yes	yes	yes	yes	yes
	H	5-0	yes	yes	yes	yes	yes	yes	yes	yes
	T	6-0	no	no	no	no	no	no	no	no

Minimum 3-Lite Slider Width is 5-0

Any unit over 96" in height or width / over 30 sqft must be tempered

## Series 6000 Window Options

### Standard Features

- Designed for New Home Construction
- Welded Sash and Master Frame
- Vinyl Brick Mould with Integral "J" Channel
- Integral Nailing Fin
- 3/4" Insulated Glass
- Sloped Sill for Better Water Run-Off
- 1-3/4" Vinyl Jamb
- 13/16" Flat Grilles
- Available in White and Tan

### Options

- Tan Color: Add 10% to List Price
- Obscure Glass: Add \$3.00/sqft of Window Area
- Bronze/Gray Tint Glass: Add \$3.00/sqft of Window Area
- Aluminum Frame, Fiberglass Mesh Half Screen
- Tempered Glass: Add \$14.04/sqft of Window Area
- Lineal "H" Mull: \$.21 per inch
- 4-9/16" Jamb Extensions Factory Applied: \$64.00
- 4-9/16" Jamb Extensions for Specialty Windows: See Specials Pages
- 6-9/16" Jamb Extensions Factory Applied: \$87.00
- Horizontal Mull: Add \$58.50
- Vertical Mull: Add \$18.71
- Tempered Obscure Glass: Add \$19.75/sqft of Window Area
- Tempered Low-E Glass: Add \$20.70/sqft of Window Area
- Niagra Obscure Glass: Add \$3.30/sqft
- Tempered Niagra Obscure Glass: Add \$21.73/sqft of Window Area
- Half Screen
- **Custom grilles (Decralite 1-piece grille): 40% upcharge**
- **Prairie Grilles: 15% upcharge**
- **Prairie (Specialty): 40% upcharge**
- **Gothic Grilles: 40% upcharge**



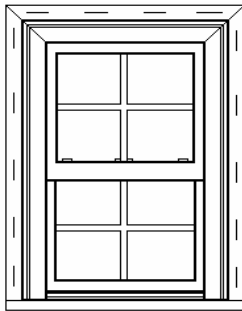

**Series 6000 SH**

**Vinyl Single Hung Windows**

- Bottom Sash Tilts In And Can Be Removed
- Interlocking Sash with Intergral Sweeplock
- Custom Sizes Available
- **Full-Sized Window: See Rough Opening Chart**  
(RO = Single Size + 1/2")
- 4-9/16" Jamb Extensions Factory Applied: \$64.00
- 6-9/16" Jamb Extensions Factory Applied: \$87.00

**Single Units**

Stock Size	1/1	GBG	Lite	Low-E	Screen
2-0 x 3-0	138.24	147.92	4/4	17.52	2.63
2-0 x 3-8	146.27	156.51	4/4	21.41	2.81
2-0 x 4-0	150.38	160.91	4/4	23.36	2.91
2-0 x 4-4	154.54	165.36	4/4	25.31	3.00
2-0 x 5-0	162.56	173.94	4/4	29.20	3.19
2-0 x 6-0	175.36	187.64	6/6	35.04	3.46
2-4 x 3-0	143.80	153.87	6/6	20.44	2.81
2-4 x 3-8	150.09	160.60	6/6	24.98	3.00
2-4 x 4-0	156.20	167.13	6/6	27.25	3.10
2-4 x 4-4	160.53	171.77	6/6	29.52	3.19
2-4 x 5-0	168.70	180.51	6/6	34.07	3.39
2-4 x 6-0	181.65	194.37	9/9	40.88	3.67
2-6 x 3-0	150.06	160.56	6/6	21.90	2.89
2-6 x 3-8	158.61	169.71	6/6	26.77	3.09
2-6 x 4-0	162.79	174.19	6/6	29.20	3.19
2-6 x 4-4	167.21	178.91	6/6	31.63	3.28
2-6 x 5-0	175.64	187.93	6/6	36.50	3.49
2-6 x 6-0	185.51	198.50	9/9	43.80	3.78
2-8 x 3-0	156.32	167.26	6/6	23.36	2.98
2-8 x 3-8	165.09	176.65	6/6	28.55	3.19
2-8 x 4-0	169.37	181.23	6/6	31.15	3.29
2-8 x 4-4	173.89	186.06	6/6	33.74	3.37
2-8 x 5-0	182.57	195.35	6/6	38.93	3.60
2-8 x 6-0	191.14	204.52	9/9	46.72	3.91
3-0 x 3-0	162.92	174.32	6/6	26.28	3.15
3-0 x 3-8	172.31	184.37	6/6	32.12	3.36
3-0 x 4-0	176.64	189.00	6/6	35.04	3.46
3-0 x 4-4	181.43	194.13	6/6	37.96	3.58
3-0 x 5-0	190.46	203.79	6/6	43.80	3.79
3-0 x 6-0	198.79	212.71	9/9	52.56	4.11
3-4 x 3-0	169.56	181.43	8/8	29.20	3.32
3-4 x 3-8	179.31	191.86	8/8	35.69	3.55
3-4 x 4-0	184.05	196.93	8/8	38.93	3.67
3-4 x 4-4	190.34	203.66	8/8	42.18	3.77
3-4 x 5-0	199.37	213.33	8/8	48.67	3.99
3-4 x 6-0	207.49	222.01	12/12	58.40	4.34
3-8 x 3-0	176.36	188.71	8/8	32.12	3.48
3-8 x 3-8	186.36	199.41	8/8	39.26	3.74
3-8 x 4-0	191.37	204.77	8/8	42.83	3.86
3-8 x 4-4	196.52	210.28	8/8	46.40	3.98
3-8 x 5-0	206.57	221.03	8/8	53.53	4.20
3-8 x 6-0	216.12	231.25	12/12	64.24	4.56
<b>Custom Size</b>	Next Larger Size + 38.50			+2.92 per sqft	+8.00

\*Screens Are Net When Purchased By Themselves

**MGM Industries**  
 287 Freehill Road  
 Hendersonville, TN 37075  
 Office 1-800-476-5584  
 Fax 1-615-822-6581

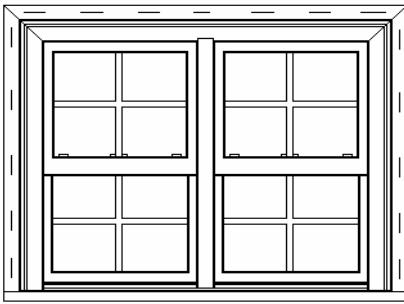

## Series 6000 TWIN

### Vinyl Single Hung Windows

- Bottom Sash Tilts In And Can Be Removed
- Interlocking Sash with Intergral Sweeplock
- "True" Twin Window, Continuous Head and Sill
- Custom Sizes Available
- **Full-Sized Window: See Rough Opening Chart**  
(RO = Twin Size + 1")
- 4-9/16" Jamb Extensions Factory Applied: \$128.00
- 6-9/16" Jamb Extensions Factory Applied: \$174.00

### Twin Units

Stock Size	1/1	GBG	Lite	Low-E	Screen
2-0 x 3-0	295.19	314.54	4/4	35.04	5.26
2-0 x 3-8	311.25	331.73	4/4	42.83	5.62
2-0 x 4-0	319.47	340.52	4/4	46.72	5.82
2-0 x 4-4	327.79	349.43	4/4	50.61	6.00
2-0 x 5-0	343.83	366.59	4/4	58.40	6.38
2-0 x 6-0	369.43	393.98	6/6	70.08	6.92
2-4 x 3-0	306.31	326.44	6/6	40.88	5.62
2-4 x 3-8	318.89	339.90	6/6	49.96	6.00
2-4 x 4-0	331.11	352.98	6/6	54.51	6.20
2-4 x 4-4	339.77	362.24	6/6	59.05	6.38
2-4 x 5-0	356.11	379.73	6/6	68.13	6.78
2-4 x 6-0	382.01	407.44	9/9	81.76	7.34
2-6 x 3-0	318.83	339.84	6/6	43.80	5.78
2-6 x 3-8	335.93	358.14	6/6	53.53	6.18
2-6 x 4-0	344.29	367.08	6/6	58.40	6.38
2-6 x 4-4	353.13	376.54	6/6	63.27	6.56
2-6 x 5-0	369.99	394.58	6/6	73.00	6.98
2-6 x 6-0	389.73	415.70	9/9	87.60	7.56
2-8 x 3-0	331.35	353.23	6/6	46.72	5.96
2-8 x 3-8	348.89	372.00	6/6	57.10	6.38
2-8 x 4-0	357.45	381.16	6/6	62.29	6.58
2-8 x 4-4	366.49	390.83	6/6	67.48	6.74
2-8 x 5-0	383.85	409.41	6/6	77.87	7.20
2-8 x 6-0	400.99	427.75	9/9	93.44	7.82
3-0 x 3-0	344.55	367.36	6/6	52.56	6.30
3-0 x 3-8	363.33	387.45	6/6	64.24	6.72
3-0 x 4-0	371.99	396.72	6/6	70.08	6.92
3-0 x 4-4	381.57	406.97	6/6	75.92	7.16
3-0 x 5-0	399.63	426.29	6/6	87.60	7.58
3-0 x 6-0	416.29	444.12	9/9	105.12	8.22
3-4 x 3-0	357.83	381.57	8/8	58.40	6.64
3-4 x 3-8	377.33	402.43	8/8	71.38	7.10
3-4 x 4-0	386.81	412.58	8/8	77.87	7.34
3-4 x 4-4	399.39	426.04	8/8	84.36	7.54
3-4 x 5-0	417.45	445.36	8/8	97.33	7.98
3-4 x 6-0	433.69	462.74	12/12	116.80	8.68
3-8 x 3-0	371.43	396.12	8/8	64.24	6.96
3-8 x 3-8	391.43	417.52	8/8	78.52	7.48
3-8 x 4-0	401.45	428.24	8/8	85.65	7.72
3-8 x 4-4	411.75	439.26	8/8	92.79	7.96
3-8 x 5-0	431.85	460.77	8/8	107.07	8.40
3-8 x 6-0	450.95	481.21	12/12	128.48	9.12
<b>Custom Size</b>	Next Larger Size + 77.00			+5.84 per sqft	+16.00

Screens Are Net When Purchased By Themselves

### MGM Industries

287 Freehill Road  
Hendersonville, TN 37075

Office 1-800-476-5584

Fax 1-615-822-6581

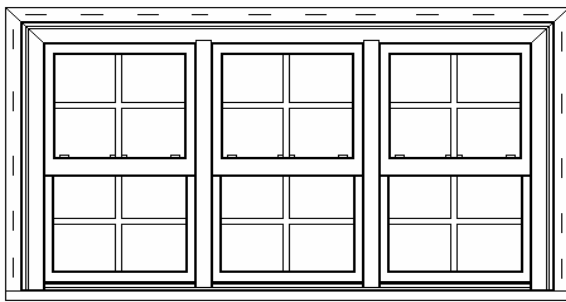

**Series 6000 TRIP**

**Vinyl Single Hung Windows**

- Bottom Sash Tilts In And Can Be Removed
- Interlocking Sash with Intergral Sweeplock
- A "True" Triple Window, Continuous Head and Sill
- Custom Sizes Available
- **Full-Sized Window: See Rough Opening Chart**  
(RO = Triple Size + 1-1/2")
- 4-9/16" Jamb Extensions Factory Applied: \$192.00
- 6-9/16" Jamb Extensions Factory Applied: \$261.00

**Triple Units**

Stock Size	1/1	GBG	Lite	Low-E	Screen
2-0 x 3-0	452.14	481.17	4/4	52.56	7.89
2-0 x 3-8	476.23	506.95	4/4	64.24	8.43
2-0 x 4-0	488.56	520.14	4/4	70.08	8.73
2-0 x 4-4	501.04	533.49	4/4	75.92	9.00
2-0 x 5-0	525.10	559.24	4/4	87.60	9.57
2-0 x 6-0	563.50	600.33	6/6	105.12	10.38
2-4 x 3-0	468.82	499.02	6/6	61.32	8.43
2-4 x 3-8	487.69	519.21	6/6	74.95	9.00
2-4 x 4-0	506.02	538.82	6/6	81.76	9.30
2-4 x 4-4	519.01	552.72	6/6	88.57	9.57
2-4 x 5-0	543.52	578.95	6/6	102.20	10.17
2-4 x 6-0	582.37	620.52	9/9	122.64	11.01
2-6 x 3-0	487.60	519.11	6/6	65.70	8.67
2-6 x 3-8	513.25	546.56	6/6	80.30	9.27
2-6 x 4-0	525.79	559.98	6/6	87.60	9.57
2-6 x 4-4	539.05	574.16	6/6	94.90	9.84
2-6 x 5-0	564.34	601.22	6/6	109.50	10.47
2-6 x 6-0	593.95	632.91	9/9	131.40	11.34
2-8 x 3-0	506.38	539.21	6/6	70.08	8.94
2-8 x 3-8	532.69	567.36	6/6	85.65	9.57
2-8 x 4-0	545.53	581.10	6/6	93.44	9.87
2-8 x 4-4	559.09	595.61	6/6	101.23	10.11
2-8 x 5-0	585.13	623.47	6/6	116.80	10.80
2-8 x 6-0	610.84	650.98	9/9	140.16	11.73
3-0 x 3-0	526.18	560.39	6/6	78.84	9.45
3-0 x 3-8	554.35	590.54	6/6	96.36	10.08
3-0 x 4-0	567.34	604.43	6/6	105.12	10.38
3-0 x 4-4	581.71	619.81	6/6	113.88	10.74
3-0 x 5-0	608.80	648.80	6/6	131.40	11.37
3-0 x 6-0	633.79	675.54	9/9	157.68	12.33
<b>Custom Size</b>	Next Larger Size + 115.50			+8.76 per sqft	+24.00

Screens Are Net When Purchased By Themselves  
**\*3-0 x 6-0 is the largest size triple available factory mullled**

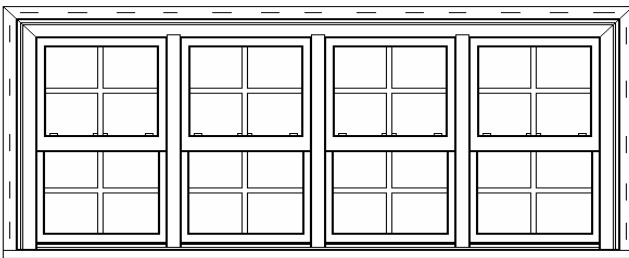

**Series 6000 QUAD  
Vinyl Single Hung Windows**

- Bottom Sash Tilts In and Can Be Removed
- Interlocking Sash with Intergral Sweeplock
- A "True" Quad Window, Continuous Head and Sill on 2-0, 2-4, 2-6, 2-8 Widths
- Custom Sizes Available
- **Full-Sized Window: See Rough Opening Chart**  
(RO = Quad Size + 2")
- 4-9/16" Jamb Extensions Factory Applied: \$256.00
- 6-9/16" Jamb Extensions Factory Applied: \$348.00

**Quad Units**

Stock Size	1/1	GBG	Lite	Low-E	Screen
2-0 x 3-0	609.09	647.80	4/4	70.08	10.52
2-0 x 3-8	641.21	682.17	4/4	85.65	11.24
2-0 x 4-0	657.65	699.76	4/4	93.44	11.64
2-0 x 4-4	674.29	717.56	4/4	101.23	12.00
2-0 x 5-0	706.37	751.89	4/4	116.80	12.76
2-0 x 6-0	757.57	806.67	6/6	140.16	13.84
2-4 x 3-0	631.33	671.59	6/6	81.76	11.24
2-4 x 3-8	656.49	698.52	6/6	99.93	12.00
2-4 x 4-0	680.93	724.67	6/6	109.01	12.40
2-4 x 4-4	698.25	743.20	6/6	118.10	12.76
2-4 x 5-0	730.93	778.17	6/6	136.27	13.56
2-4 x 6-0	782.73	833.59	9/9	163.52	14.68
2-6 x 3-0	656.37	698.39	6/6	87.60	11.56
2-6 x 3-8	690.57	734.98	6/6	107.07	12.36
2-6 x 4-0	707.29	752.87	6/6	116.80	12.76
2-6 x 4-4	724.97	771.79	6/6	126.53	13.12
2-6 x 5-0	758.69	807.87	6/6	146.00	13.96
2-6 x 6-0	798.17	850.11	9/9	175.20	15.12
2-8 x 3-0	681.41	725.18	6/6	93.44	11.92
2-8 x 3-8	716.49	762.72	6/6	114.20	12.76
2-8 x 4-0	733.61	781.03	6/6	124.59	13.16
2-8 x 4-4	751.69	800.38	6/6	134.97	13.48
2-8 x 5-0	786.41	837.53	6/6	155.73	14.40
2-8 x 6-0	820.69	874.21	9/9	186.88	15.64
<b>Widths Over 2-8 are Shipped as 2 Factory Mulls</b>					
↓ <b>Twins with a Precut Field H-Mull</b> ↓					
3-0 x 3-0	707.81	753.43	6/6	105.12	12.60
3-0 x 3-8	745.37	793.62	6/6	128.48	13.44
3-0 x 4-0	762.69	812.15	6/6	140.16	13.84
3-0 x 4-4	781.85	832.65	6/6	151.84	14.32
3-0 x 5-0	817.97	871.30	6/6	175.20	15.16
3-0 x 6-0	851.29	906.95	9/9	210.24	16.44
3-4 x 3-0	734.37	781.85	8/8	116.80	13.28
3-4 x 3-8	773.37	823.58	8/8	142.76	14.20
3-4 x 4-0	792.33	843.86	8/8	155.73	14.68
3-4 x 4-4	817.49	870.79	8/8	168.71	15.08
3-4 x 5-0	853.61	909.43	8/8	194.67	15.96
3-4 x 6-0	886.09	944.19	12/12	233.60	17.36
3-8 x 3-0	761.57	810.95	8/8	128.48	13.92
3-8 x 3-8	801.57	853.75	8/8	157.03	14.96
3-8 x 4-0	821.61	875.19	8/8	171.31	15.44
3-8 x 4-4	842.21	897.24	8/8	185.58	15.92
3-8 x 5-0	882.41	940.25	8/8	214.13	16.80
3-8 x 6-0	920.61	981.12	12/12	256.96	18.24
<b>Custom Size</b>	Next Larger Size +154.00			+11.68 per sqft	+32.00

**MGM Industries**  
 287 Freehill Road  
 Hendersonville, TN 37075  
 Office 1-800-476-5584  
 Fax 1-615-822-6581

**Screens Are Net When Purchased By Themselves**



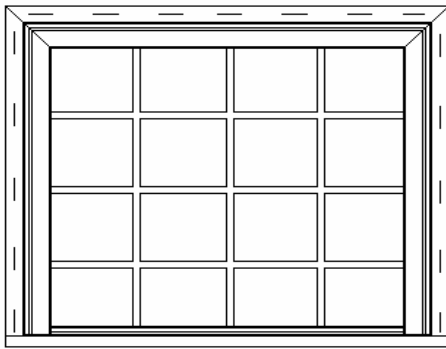

**Series 6000 PIC**

**Vinyl Fixed Picture Windows**

- Box Sill
- Custom Sizes Available
- 4-9/16" Jamb Extensions Factory Applied: \$64.00
- 6-9/16" Jamb Extensions Factory Applied: \$87.00

**Fixed Windows**

Size	1/1	GBG	Lite	Low-E	Tempered
2-0 x 3-0	109.95	118.75	8	17.52	84.24
2-0 x 3-8	119.62	129.19	8	21.41	102.96
2-0 x 4-0	127.67	137.88	8	23.36	112.32
2-0 x 4-4	136.69	147.63	8	25.31	121.68
2-0 x 5-0	142.99	154.43	8	29.20	140.40
2-0 x 6-0	164.93	178.12	12	35.04	168.48
2-8 x 3-0	120.97	130.65	12	23.36	112.32
2-8 x 3-8	130.51	140.95	12	28.55	137.28
2-8 x 4-0	140.18	151.39	12	31.15	149.76
2-8 x 4-4	143.42	154.89	12	33.74	162.24
2-8 x 5-0	162.27	175.25	12	38.93	187.20
2-8 x 6-0	185.69	200.55	18	46.72	224.64
3-0 x 3-0	127.28	137.46	12	26.28	126.36
3-0 x 3-8	135.73	146.59	12	32.12	154.44
3-0 x 4-0	143.52	155.00	12	35.04	168.48
3-0 x 4-4	146.76	158.50	12	37.96	182.52
3-0 x 5-0	167.76	181.18	12	43.80	210.60
3-0 x 6-0	188.77	203.87	18	52.56	252.72
4-0 x 3-0	143.85	155.36	16	35.04	168.48
4-0 x 3-8	162.13	175.10	16	42.83	205.92
4-0 x 4-0	175.79	189.85	16	46.72	224.64
4-0 x 4-4	179.04	193.36	16	50.61	243.36
4-0 x 5-0	184.48	199.24	16	58.40	280.80
4-0 x 6-0	263.32	284.39	24	70.08	336.96
5-0 x 3-0	168.42	181.89	20	43.80	210.60
5-0 x 3-8	176.37	190.48	20	53.53	257.40
5-0 x 4-0	184.78	199.56	20	58.40	280.80
5-0 x 4-4	191.99	207.35	20	63.27	304.20
5-0 x 5-0	272.95	294.79	20	73.00	351.00
5-0 x 6-0	290.84	314.11	30	87.60	421.20
6-0 x 3-0	187.71	202.73	24	52.56	252.72
6-0 x 3-8	232.60	251.21	24	64.24	308.88
6-0 x 4-0	273.28	295.14	24	70.08	336.96
6-0 x 4-4	278.97	301.29	24	75.92	365.04
6-0 x 5-0	285.17	307.98	24	87.60	421.20
<b>*6-0 x 6-0</b>	320.62	346.27	36	105.12	505.44
Custom Size	Next Larger Size + \$38.50			2.92/sqft	14.04/sqft
<b>* Windows with over 30 sqft of glass are required to be tempered</b>					

**MGM Industries**  
 287 Freehill Road  
 Hendersonville, TN 37075  
 Office 1-800-476-5584  
 Fax 1-615-822-6581

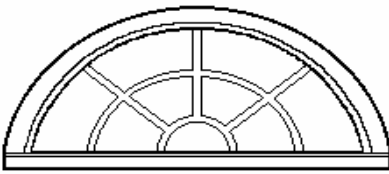

**Series 6000 HR**  
**Vinyl Half Round Windows**

Size	1-Lite	Low-E	Tempered
2-4	227.06	7.95	38.22
2-6	227.06	9.13	43.88
2-8	273.02	10.38	49.92
3-0	273.02	13.14	63.18
3-4	323.61	16.22	78.00
3-8	367.85	19.63	94.38
4-0 (2-0 Twin)	376.86	23.36	112.32
4-8 (2-4 Twin)	385.35	31.80	152.88
5-0 (2-6 Twin)	409.35	36.50	175.50
5-4 (2-8 Twin)	452.69	41.53	199.68
6-0 (3-0 Twin)	495.01	52.56	252.72
6-8 (3-4 Twin)	529.77	64.89	312.00
<b>7-4 (3-8 Twin)*</b>	<b>577.06</b>	<b>78.52</b>	<b>377.52</b>
<b>Custom Size</b>	Next Larger Size + 59.00	14.04/sqft	14.04/sqft

Size	Primed 4-9/16" Jamb Ext.	Primed 6-9/16" Jamb Ext.
2-4	71.80	102.57
2-6	76.93	115.39
2-8	76.93	115.39
3-0	82.06	128.21
3-4	89.75	141.03
3-8	89.75	141.03
4-0 (2-0 Twin)	89.75	141.03
4-8 (2-4 Twin)	102.57	153.85
5-0 (2-6 Twin)	102.57	153.85
5-4 (2-8 Twin)	141.03	179.49
6-0 (3-0 Twin)	141.03	179.49
6-8 (3-4 Twin)	150.20	191.16
<b>7-4 (3-8 Twin)*</b>	<b>150.20</b>	<b>191.16</b>

\* **Must be 2 pieces welded together if over 84"**

\*\* Please specify lettered grille pattern from pages 6000-6A or 6000-6B when ordering

- **Factory Mull Charge: \$58.50**
- Mull "Prep": \$18.71 (Prepared for job-site mulling)
- Tempered Low-E Glass: Add \$24.85/sqft of Window Area

**MGM Industries**  
 287 Freehill Road  
 Hendersonville, TN 37075  
 Office 1-800-476-5584  
 Fax 1-615-822-6581

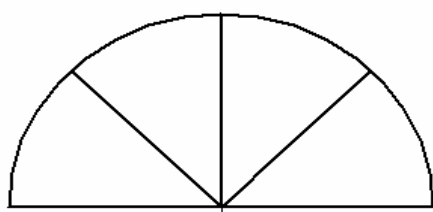

**A**

3 - Spoke  
\$12.00

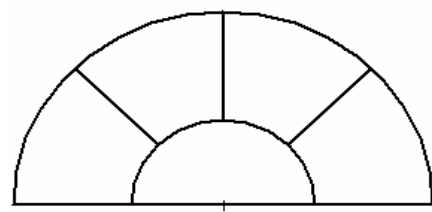

**B**

3 - Spoke Open Hub  
\$23.49

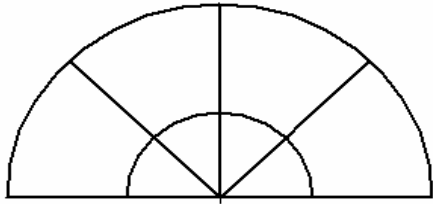

**C**

3 - Spoke Open Hub Starburst  
\$38.49

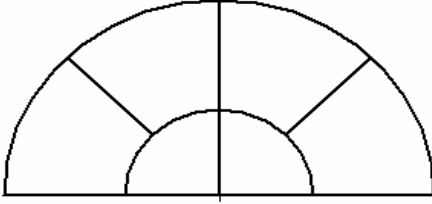

**D**

3 - Spoke Open Hub Starburst CBO  
\$38.49

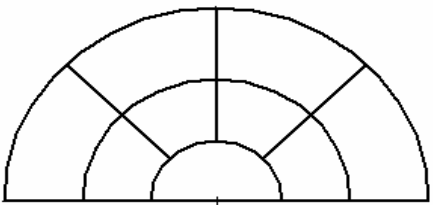

**E**

3 - Spoke 2-Open Hubs  
\$89.19

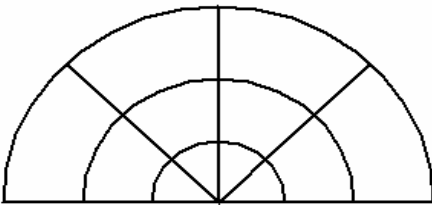

**F**

3 - Spoke 2-Open Hubs Starburst  
\$114.19

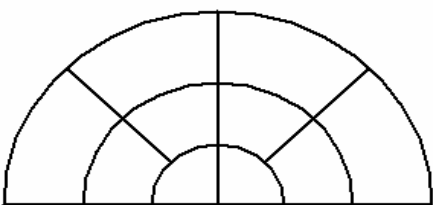

**G**

3 - Spoke 2-Open Hubs Starburst CBO  
\$114.19

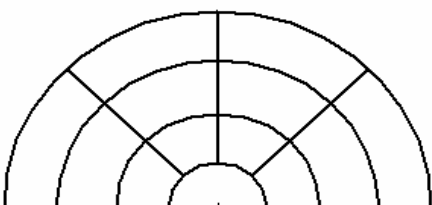

**H**

3 - Spoke 3-Open Hubs  
\$151.69

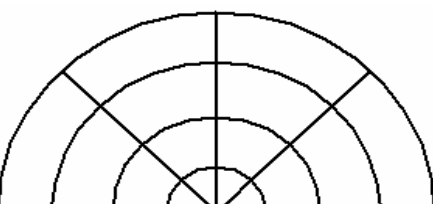

**I**

3 - Spoke 3-Open Hubs Starburst  
\$176.69

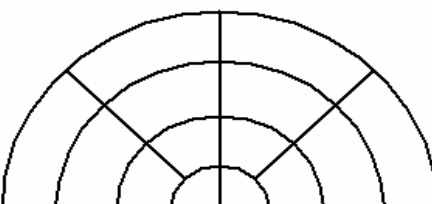

**J**

3 - Spoke 3-Open Hubs Starburst CBO  
\$176.69

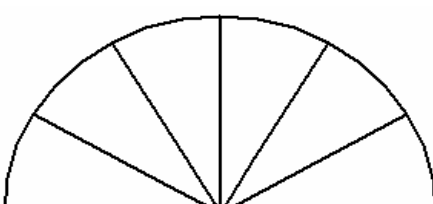

**K**

5 - Spoke  
\$16.30

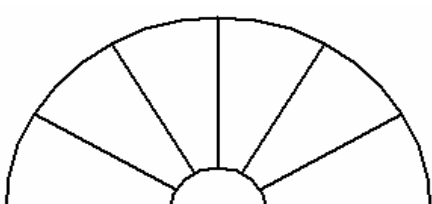

**L**

5 - Spoke Open Hub  
\$27.80

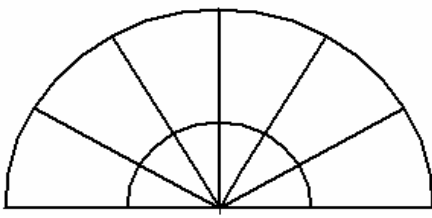

**M**

5 - Spoke Open Hub Starburst  
\$42.80

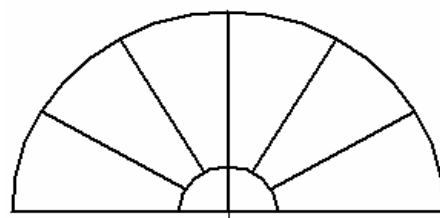

**N**

5 - Spoke Open Hub Starburst CBO  
\$42.80

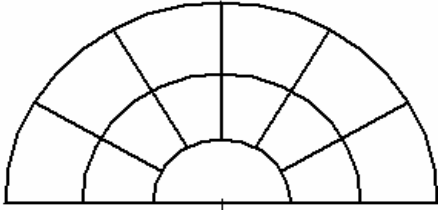

**O**

5 - Spoke 2-Hub  
\$93.19

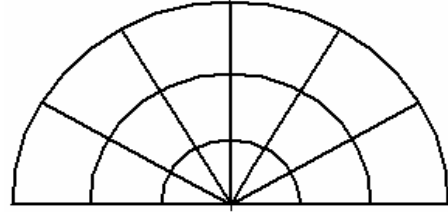

**P**

5 - Spoke 2-Open Hub Starburst  
\$118.19

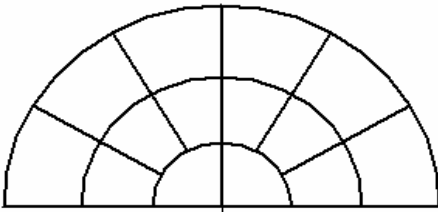

**Q**

5 - Spoke 2-Open Hub Starburst CBO  
\$118.19

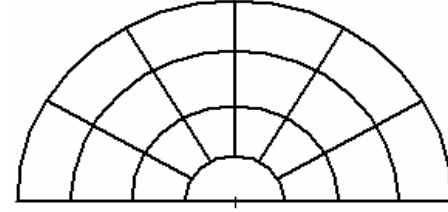

**R**

5 - Spoke 3-Hub  
\$155.69

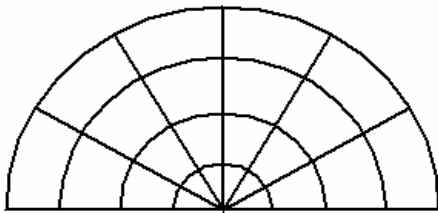

**S**

5 - Spoke 3-Open Hub Starburst  
\$180.69

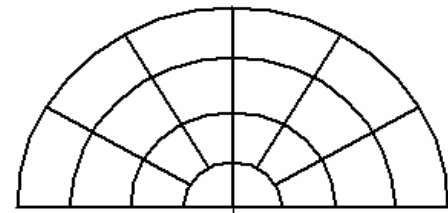

**T**

5 - Spoke 3-Open Hub Starburst CBO  
\$180.69

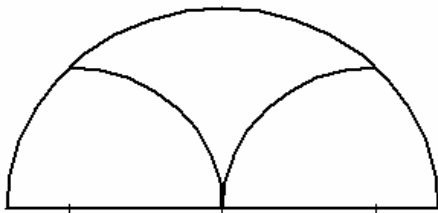

**U**

1 - Point Gothic

Gothic Patterns  
+40% of 1/1 Price

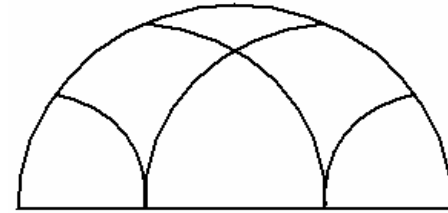

**V**

2 - Point Gothic

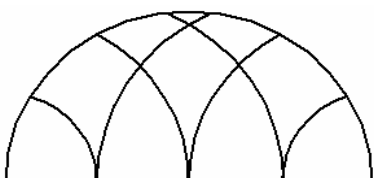

**W**

3 - Point Gothic



**X**

4 - Point Gothic

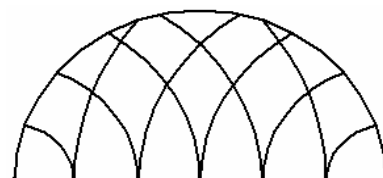

**Y**

5 - Point Gothic

Note: Gothic Grille Radius will vary somewhat with the width of the Half Round

to check to see if the grille you've picked works in the size Half Round you want

No = Can't use this grille in this size Half Round

NR = Not Recommended due to either appearance or is not architecturally correct but can be built at your risk

Yes = This grille works well in this size Half Round

	Ref Ltr	2-4	2-6	2-8	3-0	3-4	3-8	4-0	2-0TW
3 - Spoke	A	NR	NR	NR	NR	Yes	Yes	Yes	Yes
3 - Spoke Open Hub	B	Yes	Yes	Yes	Yes	Yes	Yes	Yes	Yes
3 - Spoke Open Hub Starburst	C	NR	NR	NR	NR	Yes	Yes	Yes	Yes
3 - Spoke Open Hub Starburst CBO	D	NR	NR	NR	NR	Yes	Yes	Yes	Yes
3 - Spoke 2-Open Hubs	E	No	No	No	No	No	No	No	No
3 - Spoke 2-Open Hubs Starburst	F	No	No	No	No	No	No	No	No
3 - Spoke 2-Open Hubs Starburst CBO	G	No	No	No	No	No	No	No	No
3 - Spoke 3-Open Hubs	H	No	No	No	No	No	No	No	No
3 - Spoke 3-Open Hubs Starburst	I	No	No	No	No	No	No	No	No
3 - Spoke 3-Open Hubs Starburst CBO	J	No	No	No	No	No	No	No	No
5 - Spoke	K	NR	NR	NR	NR	Yes	Yes	Yes	Yes
5 - Spoke Open Hub	L	NR	NR	NR	NR	Yes	Yes	Yes	Yes
5 - Spoke Open Hub Starburst	M	No	No	No	No	Yes	Yes	Yes	Yes
5 - Spoke Open Hub Starburst CBO	N	No	No	No	No	Yes	Yes	Yes	Yes
5 - Spoke 2-Open Hubs	O	No	No	No	No	No	No	No	No
5 - Spoke 2-Open Hubs Starburst	P	No	No	No	No	No	No	No	No
5 - Spoke 2-Open Hubs Starburst CBO	Q	No	No	No	No	No	No	No	No
5 - Spoke 3-Open Hubs	R	No	No	No	No	No	No	No	No
5 - Spoke 3-Open Hubs Starburst	S	No	No	No	No	No	No	No	No
5 - Spoke 3-Open Hubs Starburst CBO	T	No	No	No	No	No	No	No	No
1 - Point Gothic	U	NR	NR	NR	NR	NR	NR	NR	NR
2 - Point Gothic	V	Yes	Yes	Yes	Yes	NR	NR	NR	NR
3 - Point Gothic	W	No	No	No	No	Yes	Yes	Yes	Yes
4 - Point Gothic	X	No	No	No	No	No	No	No	No
5 - Point Gothic	Y	No	No	No	No	No	No	No	No

to check to see if the grille you've picked works in the size Half Round you want

No = Can't use this grille in this size Half Round

NR = Not Recommended due to either appearance or is not architecturally correct but can be built at your risk

Yes = This grille works well in this size Half Round

	Ref Ltr	2-4TW	5-0	2-6TW	103010	2-8TW	6-0	3-0TW	3-4TW
3 - Spoke	A	Yes	NR	Yes	NR	Yes	Yes	Yes	Yes
3 - Spoke Open Hub	B	Yes	Yes	Yes	Yes	Yes	Yes	Yes	Yes
3 - Spoke Open Hub Starburst	C	Yes	NR	Yes	NR	Yes	Yes	Yes	Yes
3 - Spoke Open Hub Starburst CBO	D	Yes	NR	Yes	NR	Yes	Yes	Yes	Yes
3 - Spoke 2-Open Hubs	E	Yes	Yes	Yes	Yes	Yes	Yes	Yes	Yes
3 - Spoke 2-Open Hubs Starburst	F	Yes	NR	Yes	NR	Yes	Yes	Yes	Yes
3 - Spoke 2-Open Hubs Starburst CBO	G	Yes	NR	Yes	NR	Yes	Yes	Yes	Yes
3 - Spoke 3-Open Hubs	H	No	No	No	No	No	No	No	Yes
3 - Spoke 3-Open Hubs Starburst	I	No	No	No	No	No	No	No	Yes
3 - Spoke 3-Open Hubs Starburst CBO	J	No	No	No	No	No	No	No	Yes
5 - Spoke	K	Yes	Yes	Yes	NR	Yes	Yes	Yes	Yes
5 - Spoke Open Hub	L	Yes	Yes	Yes	Yes	Yes	Yes	Yes	Yes
5 - Spoke Open Hub Starburst	M	Yes	NR	Yes	NR	Yes	Yes	Yes	Yes
5 - Spoke Open Hub Starburst CBO	N	Yes	NR	Yes	NR	Yes	Yes	Yes	Yes
5 - Spoke 2-Open Hubs	O	Yes	Yes	Yes	Yes	Yes	Yes	Yes	Yes
5 - Spoke 2-Open Hubs Starburst	P	Yes	NR	Yes	NR	Yes	Yes	Yes	Yes
5 - Spoke 2-Open Hubs Starburst CBO	Q	Yes	NR	Yes	NR	Yes	Yes	Yes	Yes
5 - Spoke 3-Open Hubs	R	No	No	No	No	No	No	No	Yes
5 - Spoke 3-Open Hubs Starburst	S	No	No	No	No	No	No	No	Yes
5 - Spoke 3-Open Hubs Starburst CBO	T	No	No	No	No	No	No	No	Yes
1 - Point Gothic	U	NR	NR	NR	No	NR	NR	NR	No
2 - Point Gothic	V	NR	NR	NR	No	NR	NR	NR	No
3 - Point Gothic	W	NR	NR	NR	No	NR	NR	NR	No
4 - Point Gothic	X	NR	Yes	NR	No	NR	NR	NR	No
5 - Point Gothic	Y	Yes	No	Yes	No	Yes	Yes	Yes	No

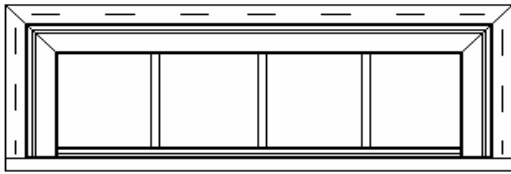

## Series 6000 TR

### 1-Piece Vinyl Fixed Transoms

- **Horizontal Mull: \$58.50**
- Mull "Prep": \$18.71 (Prepared for job-site mulling)
- 4-9/16" Jamb Extensions Factory Applied: \$38.50
- 6-9/16" Jamb Extensions Factory Applied: \$52.00

### - 2 and 3 Piece Factory Mulling Units

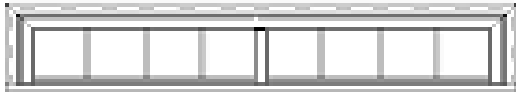

Example: 3/0 Twin x 12" 2-Piece Transom

Price: \$114.46+\$114.46+\$58.50+\$18.71

[(3/0 x 12") + (3/0 x 12") + Horizontal Mull + Vertical Mull]

**\*\* Please specify 2-piece, 3-piece or continuous when ordering**

Size	1/1	GBG	Low-E	Tempered
2-0 x 12"	85.90	93.63	5.84	28.08
2-4 x 12"	95.45	104.04	6.81	32.76
2-6 x 12"	100.22	109.24	7.30	35.10
2-8 x 12"	104.99	114.44	7.79	37.44
3-0 x 12"	114.46	124.76	8.76	42.12
3-8 x 12"	126.88	138.30	10.71	51.48
4-0 x 12"	129.61	141.27	11.68	56.16
5-0 x 12"	137.80	150.20	14.60	70.20
6-0 x 12"	146.02	159.16	17.52	84.24
2-0 x 14"	98.79	107.68	6.81	32.76
2-4 x 14"	109.77	119.65	7.95	38.22
2-6 x 14"	115.25	125.62	8.52	40.95
2-8 x 14"	120.74	131.61	9.08	43.68
3-0 x 14"	131.63	143.48	10.22	49.14
3-8 x 14"	145.91	159.04	12.49	60.06
4-0 x 14"	149.05	162.46	13.63	65.52
5-0 x 14"	158.47	172.73	17.03	81.90
6-0 x 14"	167.92	183.03	20.44	98.28
<b>Custom Size</b>	Next Larger Size + 38.50		2.92/sqft	14.04/sqft

**\* Windows with an 96 inch or greater length of glass are required to be tempered**

## MGM Industries

287 Freehill Road

Hendersonville, TN 37075

Office 1-800-476-5584

Fax 1-615-822-6581

2/2/07 6000-7

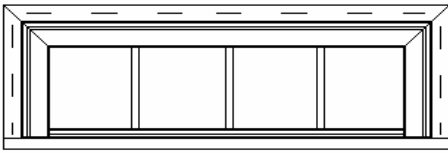

**Series 6000 TR**

**1-Piece Vinyl Fixed Transoms**

- **Horizontal Mull: \$58.50**
- Mull "Prep": \$18.71 (Prepared for job-site mulling)
- 4-9/16" Jamb Extensions Factory Applied: \$38.50
- 6-9/16" Jamb Extensions Factory Applied: \$52.00

**- 2 and 3 Piece Factory Mulling Units**

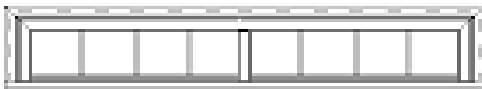

Example: 3/0 Twin x 12" 2-Piece Transom  
 Price: \$114.46+\$114.46+\$58.50+\$18.71  
 [(3/0 x 12") + (3/0 x 12") + Horizontal Mull + Vertical Mull]

**\*\* Please specify 2-piece, 3-piece or continuous when ordering**

Size	1/1	GBG	Low-E	Tempered
2-0x 18"	118.55	129.22	8.76	42.12
2-4 x 18"	131.72	143.57	10.22	49.14
2-6 x 18"	138.30	150.75	10.95	52.65
2-8 x 18"	144.89	157.93	11.68	56.16
3-0 x 18"	157.96	172.18	13.14	63.18
3-8 x 18"	175.09	190.85	16.06	77.22
4-0 x 18"	178.86	194.96	17.52	84.24
5-0 x 18"	190.18	207.30	21.90	105.30
6-0 x 18"	201.50	219.64	26.28	126.36
2-0x 24"	142.26	155.06	11.68	56.16
2-4 x 24"	158.07	172.30	13.63	65.52
2-6 x 24"	165.96	180.90	14.60	70.20
2-8 x 24"	173.87	189.52	15.57	74.88
3-0 x 24"	189.55	206.61	17.52	84.24
3-8 x 24"	210.11	229.02	21.41	102.96
4-0 x 24"	214.63	233.95	23.36	112.32
5-0 x 24"	228.21	248.75	29.20	140.40
6-0 x 24"	241.80	263.56	35.04	168.48
<b>Custom Size</b>	Next Larger Size + 38.50		2.92/sqft	14.04/sqft

**\* Windows with an 96 inch or greater length of glass are required to be tempered**



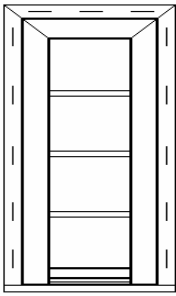

**Series 6000 PIC**

**Vinyl Fixed Flanker Windows**

- Horizontal Mull: \$58.50
- Mull "Prep": \$18.71 (Prepared for job-site mulling)
- Vertical Mull: Add \$18.71
- 4-9/16" Jamb Extensions Factory Applied: \$38.50
- 6-9/16" Jamb Extensions Factory Applied: \$52.00

Stock Sizes	1-Lite	GBG	Lite	Low-E	Tempered
12" x 2-0	99.58	108.54	2	5.84	28.08
12" x 3-0	114.46	124.76	4	8.76	42.12
12" x 3-8	126.88	138.30	4	10.71	51.48
12" x 4-0	129.61	141.27	4	11.68	56.16
12" x 4-4	132.77	144.72	4	12.65	60.84
12" x 5-0	137.81	150.21	4	14.60	70.20
12" x 5-6	142.42	155.24	4	16.06	77.22
12" x 6-0	146.02	159.16	6	17.52	84.24
14" x 2-0	114.52	124.83	2	6.81	32.76
14" x 3-0	131.63	143.48	4	10.22	49.14
14" x 3-8	145.91	159.04	4	12.49	60.06
14" x 4-0	149.05	162.46	4	13.63	65.52
14" x 4-4	152.69	166.43	4	14.76	70.98
14" x 5-0	158.48	172.74	4	17.03	81.90
14" x 5-6	163.78	178.52	4	18.74	90.09
14" x 6-0	167.92	183.03	6	20.44	98.28
<b>Custom Size</b>	Next Larger Size + 38.50			2.92/sqft	14.04/sqft

**MGM Industries**  
 287 Freehill Road  
 Hendersonville, TN 37075  
 Office 1-800-476-5584  
 Fax 1-615-822-6581

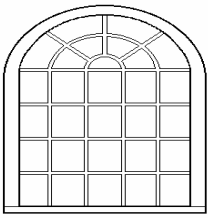

**Series 6000 RTPW**

**Round Top Picture Windows**

Sizes	RTPW					Primed 4-9/16"	Primed 6-9/16"
	Std GBG	1-Lite	GBG	Low-E	Tempered	Jamb Ext.	Jamb Ext.
2-4 x 4-0	B33	481.00	524.00	27.25	131.04	128.11	153.75
2-4 x 5-0	B34	540.00	589.00	34.07	163.80	128.11	153.75
2-4 x 6-0	B35	616.00	672.00	40.88	196.56	128.11	153.75
2-4 x 7-0	B36	691.00	753.00	47.69	229.32	128.11	153.75
2-8 x 4-0	B33	548.00	597.00	31.15	149.76	135.80	166.57
2-8 x 5-0	B34	608.00	663.00	38.93	187.20	135.80	166.57
2-8 x 6-0	B35	698.00	762.00	46.72	224.64	135.80	166.57
2-8 x 7-0	B36	866.00	945.00	54.51	262.08	135.80	166.57
3-0 x 4-0	B33	548.00	597.00	35.04	168.48	140.93	179.39
3-0 x 5-0	B34	608.00	663.00	43.80	210.60	140.93	179.39
3-0 x 6-0	B35	698.00	762.00	52.56	252.72	140.93	179.39
3-0 x 7-0	B36	866.00	945.00	61.32	294.84	140.93	179.39
3-4 x 4-0	C43	729.00	795.00	38.93	187.20	146.06	192.21
3-4 x 5-0	C44	963.00	1050.00	48.67	234.00	146.06	192.21
3-4 x 6-0	C45	1111.00	1212.00	58.40	280.80	146.06	192.21
3-4 x 7-0	C46	1217.00	1327.00	68.13	327.60	146.06	192.21
4-0 x 4-0	C43	729.00	795.00	46.72	224.64	153.75	205.03
4-0 x 5-0	C44	963.00	1050.00	58.40	280.80	153.75	205.03
4-0 x 6-0	C45	1111.00	1212.00	70.08	336.96	153.75	205.03
<b>*4-0 x 7-0</b>	C46	1217.00	1327.00	81.76	393.12	153.75	205.03
5-0 x 5-0	E53	1142.00	1246.00	73.00	351.00	153.75	205.03
5-0 x 6-0	E54	1295.00	1481.00	87.60	421.20	153.75	205.03
<b>*5-0 x 7-0</b>	E55	1377.00	1563.00	102.20	491.40	153.75	205.03
5-4 x 5-0	E53	1195.00	1357.00	77.87	374.40	166.57	217.85
<b>*5-4 x 6-0</b>	E54	1335.00	1527.00	93.44	449.28	166.57	217.85
<b>*5-4 x 7-0</b>	E55	1412.00	1626.00	109.01	524.16	166.57	217.85
6-0 x 5-0	F62	1284.00	1498.00	87.60	421.20	205.03	243.49
<b>*6-0 x 6-0</b>	F63	1463.00	1691.00	105.12	505.44	205.03	243.49
<b>*6-0 x 7-0</b>	F64	1553.00	1795.00	122.64	589.68	205.03	243.49
<b>All Other Sizes Must Be Quoted</b>							

\* Windows with over 30 sqft of glass are required to be tempered

All non-standard grille patterns require drawings for quoting and manufacturing

See pages 6000-9A & B for Std RTPW GBG patterns.

Tempered Low-E Glass: Add \$24.85/sqft of Window Area

**MGM Industries**

287 Freehill Road  
 Hendersonville, TN 37075  
 Office 1-800-476-5584  
 Fax 1-615-822-6581

Minimum width for A  
is 2-0

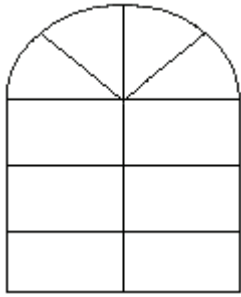

**A23**

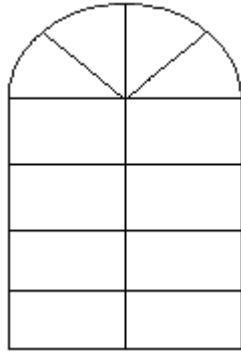

**A24**

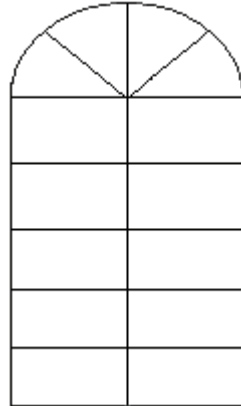

**A25**

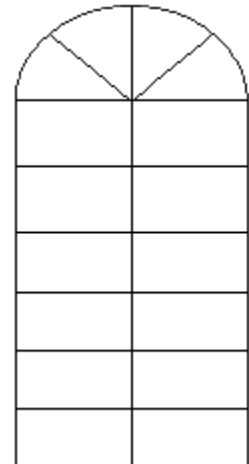

**A26**

Minimum width for B  
is 2-4

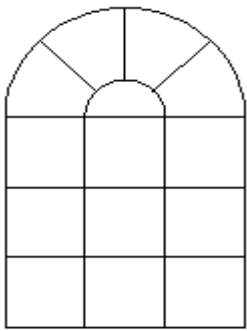

**B33**

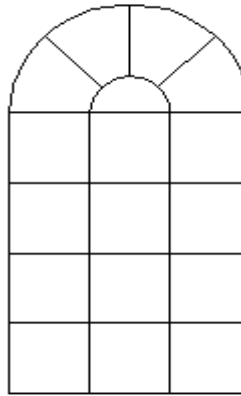

**B34**

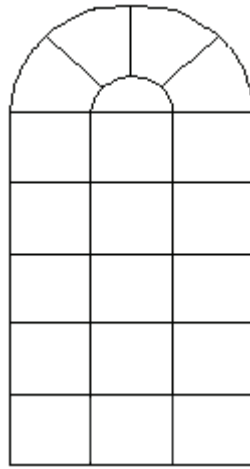

**B35**

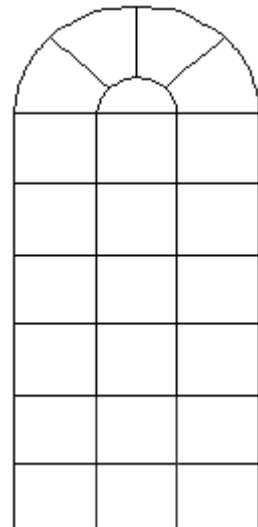

**B36**

Minimum width for C  
is 2-4

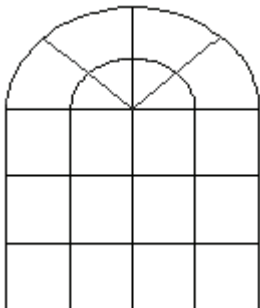

**C43**

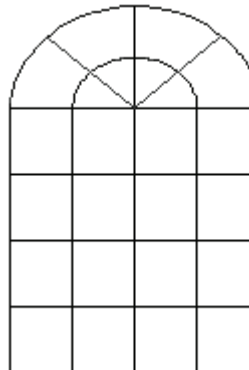

**C44**

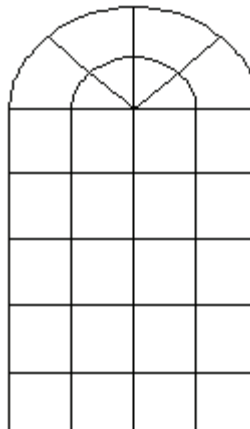

**C45**

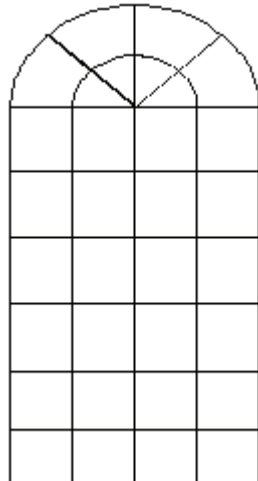

**C46**

**MGM Industries**  
287 Freehill Road  
Hendersonville, TN 37075  
Office 1-800-476-5584  
Fax 1-615-822-6581

Minimum width for E  
is 5-0

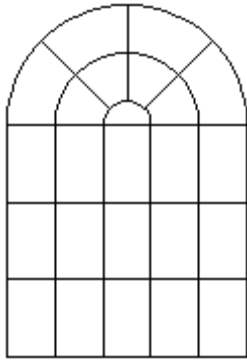

**E53**

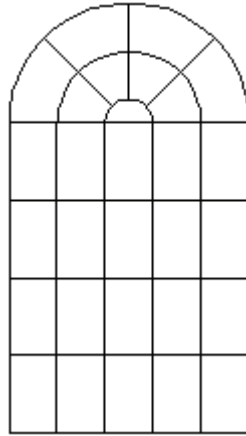

**E54**

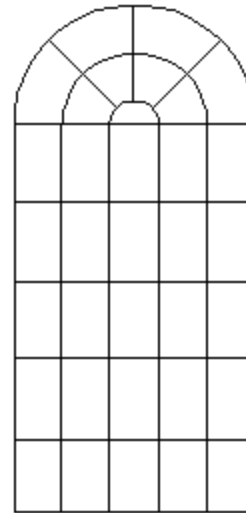

**E55**

Minimum width for F  
is 5-0

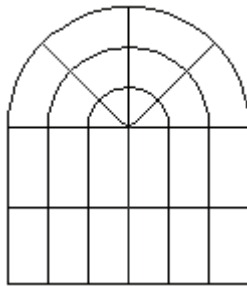

**F62**

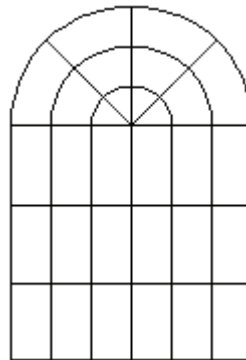

**F63**

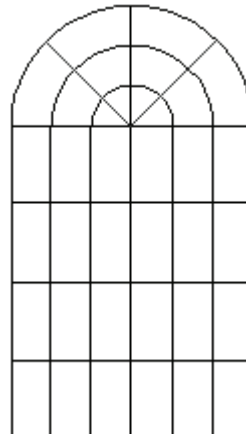

**F64**

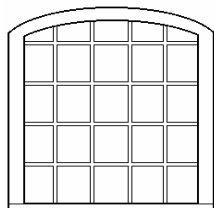

## Series 6000 STPW

### Segment Top Picture Windows

Sizes	1-Lite	GBG	Low-E	Tempered	Primed 4-9/16" Jamb Ext.	Primed 6-9/16" Jamb Ext.
2-0 x 4-0	481.00	524.00	23.36	112.32	128.11	153.75
2-0 x 5-0	540.00	589.00	29.20	140.40	128.11	153.75
2-0 x 6-0	616.00	672.00	35.04	168.48	128.11	153.75
2-0 x 7-0	691.00	753.00	40.88	196.56	128.11	153.75
2-4 x 4-0	481.00	524.00	27.25	131.04	128.11	153.75
2-4 x 5-0	540.00	589.00	34.07	163.80	128.11	153.75
2-4 x 6-0	616.00	672.00	40.88	196.56	128.11	153.75
2-4 x 7-0	691.00	753.00	47.69	229.32	128.11	153.75
2-8 x 4-0	548.00	597.00	31.15	149.76	135.80	166.57
2-8 x 5-0	608.00	663.00	38.93	187.20	135.80	166.57
2-8 x 6-0	698.00	762.00	46.72	224.64	135.80	166.57
2-8 x 7-0	866.00	945.00	54.51	262.08	135.80	166.57
3-0 x 4-0	548.00	597.00	35.04	168.48	140.93	179.39
3-0 x 5-0	608.00	663.00	43.80	210.60	140.93	179.39
3-0 x 6-0	698.00	762.00	52.56	252.72	140.93	179.39
3-0 x 7-0	866.00	945.00	61.32	294.84	140.93	179.39
3-4 x 4-0	729.00	795.00	38.93	187.20	146.06	192.21
3-4 x 5-0	963.00	1050.00	48.67	234.00	146.06	192.21
3-4 x 6-0	1111.00	1212.00	58.40	280.80	146.06	192.21
3-4 x 7-0	1217.00	1327.00	68.13	327.60	146.06	192.21
4-0 x 4-0	729.00	795.00	46.72	224.64	153.75	205.03
4-0 x 5-0	963.00	1050.00	58.40	280.80	153.75	205.03
4-0 x 6-0	1111.00	1212.00	70.08	336.96	153.75	205.03
*4-0 x 7-0	1217.00	1327.00	81.76	393.12	153.75	205.03
5-0 x 5-0	1142.00	1246.00	73.00	351.00	153.75	205.03
5-0 x 6-0	1295.00	1481.00	87.60	421.20	153.75	205.03
*5-0 x 7-0	1377.00	1563.00	102.20	491.40	153.75	205.03
5-4 x 5-0	1195.00	1357.00	77.87	374.40	166.57	217.85
*5-4 x 6-0	1335.00	1527.00	93.44	449.28	166.57	217.85
*5-4 x 7-0	1412.00	1626.00	109.01	524.16	166.57	217.85
6-0 x 5-0	1284.00	1498.00	87.60	421.20	205.03	243.49
*6-0 x 6-0	1463.00	1691.00	105.12	505.44	205.03	243.49
*6-0 x 7-0	1553.00	1795.00	122.64	589.68	205.03	243.49
<b>All Other Sizes Must Be Quoted</b>						

\* Windows with over 30 sqft of glass are required to be tempered **See pages 6000-9A & B for Std RTPW GBG patterns.**

All non-standard grille patterns require drawings for quoting and manufacturing

Patterns with any arch design (Decralite must be used) are 40% upcharge for STPW

**MGM Industries**  
 287 Freehill Road  
 Hendersonville, TN 37075  
 Office 1-800-476-5584  
 Fax 1-615-822-6581

Tempered Low-E Glass: Add \$24.85/sqft of Window Area

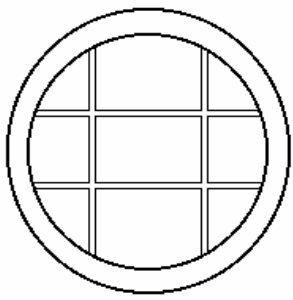

**Series 6000 RND**

**Vinyl Full Round Windows**

Diameter	1-Lite	GBG	Low-E	Tempered	Primed 4-9/16"	Primed 6-9/16"
					Jamb Ext.	Jamb Ext.
2-0	564.00	607.00	11.68	56.16	153.86	230.78
2-4	564.00	607.00	15.90	76.44	153.86	230.78
2-8	564.00	607.00	20.76	99.84	164.12	256.42
3-0	564.00	607.00	26.28	126.36	179.50	282.06
4-0	630.00	673.00	46.72	224.64	205.14	307.70
5-0	725.00	767.00	73.00	351.00	205.14	307.70
<b>All Other Sizes Must Be Quoted</b>						

- Tempered Low-E Glass: Add \$24.85/sqft  
of Window Area

**MGM Industries**  
287 Freehill Road  
Hendersonville, TN 37075  
Office 1-800-476-5584  
Fax 1-615-822-6581

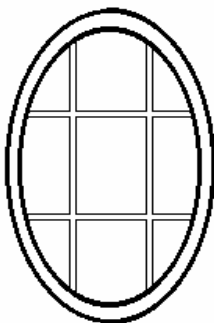

**Series 6000 OVAL**

**Vinyl Fixed Oval Windows**

Diameter	1-Lite	GBG	Low-E	Tempered	Primed 4-9/16"	Primed 6-9/16"
					Jamb Ext.	Jamb Ext.
2-0 x 3-0	564.00	625.00	17.52	84.24	153.87	215.40
3-0 x 4-0	630.00	673.00	35.04	168.48	196.95	307.71

- Tempered Low-E Glass: Add \$24.85/sqft  
of Window Area

**\* Series 6000 Ovals are Series  
5000 Ovals with Factory Applied  
Wood Extensions  
Brick Mould and J-Channel on All Oval Units**

**MGM Industries**  
287 Freehill Road  
Hendersonville, TN 37075  
Office 1-800-476-5584  
Fax 1-615-822-6581

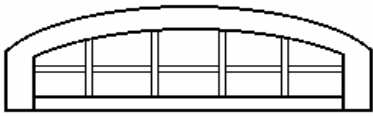

One Piece Transoms Only  
**Series 6000 STOP**



Example Using Decralite Grids

**Vinyl Segment Top Transoms**

Please Specify Leg and CH When Ordering

Size Width x CH** - Leg	1-Lite	GBG	Low-E	Tempered	Primed	Primed
					4-9/16" Jamb Ext.	6-9/16" Jamb Ext.
2-0 x 12" - 6" Leg	331.20	357.30	5.84	28.08	84.63	126.93
2-4 x 12" - 6" Leg	331.20	357.30	6.81	32.76	84.63	126.93
2-6 x 12" - 6" Leg	331.20	357.30	7.30	35.10	84.63	126.93
2-8 x 12" - 6" Leg	331.20	357.30	7.79	37.44	84.63	126.93
3-0 x 12" - 6" Leg	331.20	357.30	8.76	42.12	90.27	141.04
3-4 x 12" - 6" Leg	392.40	420.30	9.73	46.80	98.73	155.14
3-8 x 12" - 6" Leg	392.40	420.30	10.71	51.48	98.73	155.14
4-0 x 12" - 6" Leg	392.40	420.3	11.68	56.16	98.73	155.14
5-0 x 12" - 6" Leg	447.30	472.50	14.60	70.20	112.83	169.24
6-0 x 12" - 6" Leg	521.20	555.50	17.52	84.24	155.14	197.44
6-8 x 12" - 6" Leg	579.11	617.22	19.47	93.60	165.22	210.28
7-0 x 12" - 6" Leg	608.07	648.09	20.44	98.28	165.22	210.28
<b>7-4 x 12" - 6" Leg***</b>	<b>937.02</b>	<b>978.94</b>	21.41	102.96	165.22	210.28
<b>7-6 x 12" - 6" Leg***</b>	<b>951.50</b>	<b>994.37</b>	21.90	105.30	165.22	210.28
<b>8-0 x 12" - 6" Leg***</b>	<b>994.93</b>	<b>1040.66</b>	23.36	112.32	175.30	223.12
<b>9-0 x 12" - 6" Leg***</b>	<b>1081.80</b>	<b>1133.25</b>	26.28	126.36	185.38	235.96
2-0 x 24" - 6" Leg	413.80	451.10	11.68	56.16	86.32	129.47
2-4 x 24" - 6" Leg	413.80	451.10	13.63	65.52	86.32	129.47
2-6 x 24" - 6" Leg	413.80	451.10	14.60	70.20	86.32	129.47
2-8 x 24" - 6" Leg	413.80	451.10	15.57	74.88	86.32	129.47
3-0 x 24" - 6" Leg	413.80	451.10	17.52	84.24	92.08	143.86
3-4 x 24" - 6" Leg	481.00	524.00	19.47	93.60	100.70	158.24
3-8 x 24" - 6" Leg	481.00	524.00	21.41	102.96	100.70	158.24
4-0 x 24" - 6" Leg	481.00	524.00	23.36	112.32	100.70	158.24
5-0 x 24" - 6" Leg	527.50	584.50	29.20	140.40	115.09	172.62
6-0 x 24" - 6" Leg	600.20	662.20	35.04	168.48	158.24	201.39
6-8 x 24" - 6" Leg	666.89	735.78	38.93	187.20	168.52	214.49
7-0 x 24" - 6" Leg	700.23	772.49	40.88	98.28	168.52	214.49
<b>7-4 x 24" - 6" Leg***</b>	<b>1033.58</b>	<b>1109.29</b>	42.82	102.96	168.52	214.49
<b>7-6 x 24" - 6" Leg***</b>	<b>1050.25</b>	<b>1127.68</b>	43.80	105.30	168.52	214.49
<b>8-0 x 24" - 6" Leg***</b>	<b>1102.67</b>	<b>1185.51</b>	46.72	112.32	178.81	227.58
<b>9-0 x 24" - 6" Leg***</b>	<b>1203.00</b>	<b>1296.20</b>	52.56	126.36	189.09	240.68
<b>All Other Sizes Must Be Quoted</b>						

- Tempered Low-E: Add \$24.85/sqft of Window Area
- **Factory Mull Charge: \$58.50**
- Mull "Prep": \$18.71 (Unit prepared for job-site mulling)
- Gothic Grilles: Add 40% to GBG Price
- **Decralite Grilles: Call for Quote**  
**1 piece grid**

**\* Windows with 96" or greater length (in one direction) are required to be tempered**

\*\* CH = Center Height of Unit  
**\*\*\* Only available as 3-piece (Includes 3-piece adder in price)**

- 6" Leg is shortest available length

**Two Piece STOP: Add \$150.00**  
**Three Piece STOP: Add \$300.00**

**MGM Industries**  
 287 Freehill Road  
 Hendersonville, TN 37075  
 Office 1-800-476-5584  
 Fax 1-615-822-6581



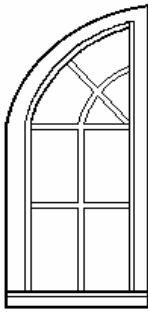

**Vinyl Quarter Round Top Picture Windows**  
**Vinyl Gothic Picture Windows**  
**Vinyl Half Segment Windows**

**Drawing Required on All Orders**

**Series 6000 QRPW**

Base	Height	1-Lite	GBG	Low-E	Tempered	Primed	Primed
						4-9/16" Jamb Ext.	6-9/16" Jamb Ext.
12" - 28"	12"	301.00	328.00	2.92/sqft	14.04/sqft	101.85	124.93
	24"	360.00	393.00				
	36"	421.00	459.00				
	48"	482.00	525.00				
	60"	541.00	590.00				
	72"	617.00	673.00				
	84"	692.00	754.00				
29" - 36"	12"	368.00	401.00	2.92/sqft	14.04/sqft	109.55	144.16
	24"	428.00	467.00				
	36"	489.00	534.00				
	48"	549.00	599.00				
	60"	609.00	664.00				
	72"	699.00	763.00				
	84"	867.00	946.00				
37" - 48"	12"	436.00	476.00	2.92/sqft	14.04/sqft	115.31	153.77
	24"	531.00	579.00				
	36"	632.00	690.00				
	48"	730.00	796.00				
	60"	963.00	1051.00				
	72"	1112.00	1213.00				
49" - 60"	12"	497.00	542.00	2.92/sqft	14.04/sqft	153.77	182.62
	24"	597.00	651.00				
	36"	737.00	804.00				
	48"	978.00	1066.00				
	60"	1143.00	1247.00				
<b>All Other Sizes Must Be Quoted</b>							

\* Windows with over 30 sqft of glass are required to be tempered

- Tempered Low-E Glass: Add \$24.85/sqft of Window Area
- **Factory Mull Charge: \$58.50**
- Mull "Prep": \$18.71 (Unit prepared for job-site mulling)

**MGM Industries**  
 287 Freehill Road  
 Hendersonville, TN 37075  
 Office 1-800-476-5584  
 Fax 1-615-822-6581

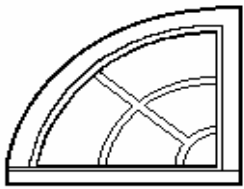

- Tempered Low-E Glass: Add \$24.84/sqft of Window Area
- **Factory Mull Charge: \$58.50**
- Mull "Prep": \$18.71 (Prepared for job-site mulling)

**Series 6000 QR**

**Vinyl Quarter Round Windows**

Size	1-Lite	Low-E	Tempered	Primed 4-9/16" Jamb Ext.	Primed 6-9/16" Jamb Ext.
2-0 x 2-0	303.00	11.68	56.16	64.11	89.75
2-4 x 2-4	303.00	15.90	76.44	71.80	102.57
2-8 x 2-8	303.00	20.76	99.84	76.93	115.39
3-0 x 3-0	303.00	26.28	126.36	82.06	128.21
3-4 x 3-4	472.00	32.44	156.00	89.75	141.03
4-0 x 4-0	472.00	46.72	224.64	89.75	141.03
5-0 x 5-0	647.00	73.00	351.00	102.57	153.85
<b>All Other Sizes Must Be Quoted</b>					

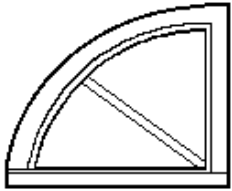

**Q1**  
\$4.00

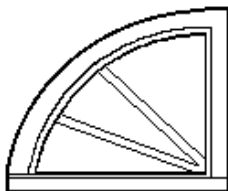

**Q2**  
\$8.00

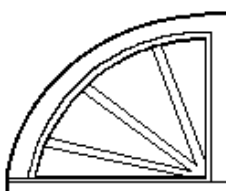

**Q3**  
\$12.00

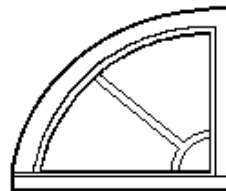

**Q4**  
\$19.00

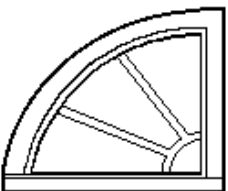

**Q5**  
\$23.00

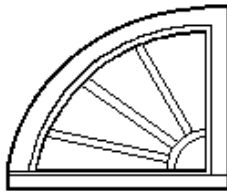

**Q6**  
\$27.00

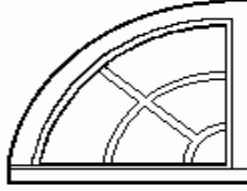

**Q7**  
\$34.00

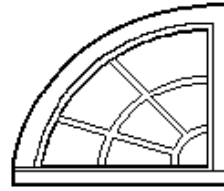

**Q8**  
\$38.00

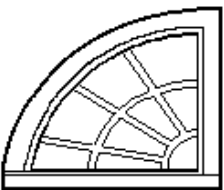

**Q9**  
\$42.00

**All Other Patterns Require Drawings for Quoting**

**MGM Industries**  
287 Freehill Road  
Hendersonville, TN 37075  
Office 1-800-476-5584  
Fax 1-615-822-6581

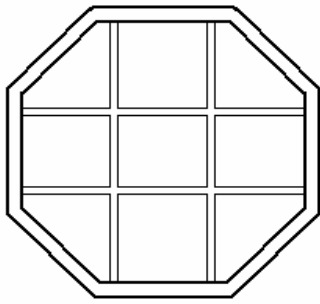

**Series 6000 OCT**

**Vinyl Octagon Windows**

Size	1-Lite	GBG	Low-E	Tempered	Primed 4-9/16"	Primed 6-9/16"
					Jamb Ext.	Jamb Ext.
2-0	212.00	235.00	11.68	56.16	64.00	87.00
2-8	314.00	356.00	20.76	99.84	64.00	87.00
3-0	314.00	356.00	26.28	126.36	64.00	87.00
<b>All Other Sizes Must Be Quoted</b>						

\* 1-8 size is no longer available

- Tempered Low-E Glass: Add \$24.85/sqft  
of Window Area

**MGM Industries**

287 Freehill Road

Hendersonville, TN 37075

Office 1-800-476-5584

Fax 1-615-822-6581

**Series 6000 TRIA**

**Vinyl Fixed Triangle Windows**

- **Factory Mull Charge: \$58.50**
- Tempered Obscure Glass: Add \$19.75/sqft of Window Area
- Tempered Low-E Glass: Add \$24.85/sqft of Window Area

\* **Windows with over 30 sqft of glass are required to be tempered**

United Inch	1-Lite	Low-E	Tempered	Primed	Primed
				4-9/16"	6-9/16"
0 - 60	507.00	2.92/sqft	14.04/sqft	192.00	261.00
61 - 84	564.00	2.92/sqft	14.04/sqft	192.00	261.00
85 - 108	621.00	2.92/sqft	14.04/sqft	192.00	261.00
109 - 132	805.00	2.92/sqft	14.04/sqft	192.00	261.00
<b>No Other Sizes Available</b>					

\* United Inch is width + height using the widest and tallest points

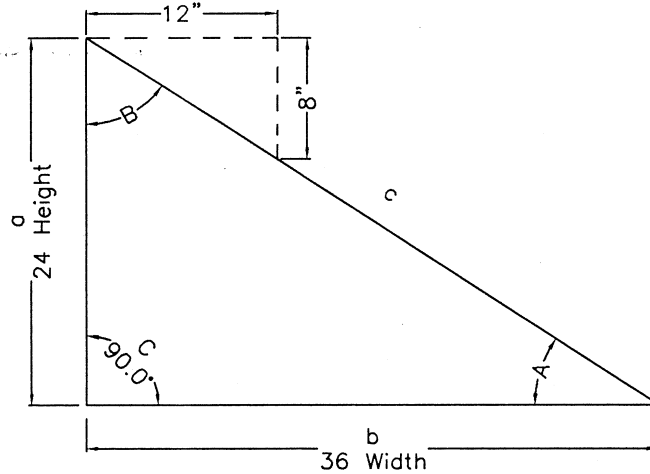

8/12 Roof Pitch  
{for every foot(12") of run, the roof drops 8"} }

**Minimum TanA allowed is .6666 (TanA=a/b)**

When Width & Pitch is Given

- 1) Convert 8/12 to TanA.  
{ 8/12 = .666(TanA) }
- 2) Multiply Width x TanA  
{ 36 x .6666 = 24 }

When Width & Height is Given

- 1) Convert 24/36 to TanA.  
{ 24/36 = .6666(TanA) }

When Pitch & Height is Given

- 1) Convert 8/12 to TanA.  
{ 8/12 = .6666(TanA) }
- 2) Convert 24/.6666 to Width.  
{ 24 / .6666 = 36 }

**a + b Not To Exceed 132 United Inches**

Grilles	
2 Lite	12.20/Sash
4 Lite	12.20/Sash
6 Lite	14.60/Sash
8 Lite	16.08/Sash
9 Lite	19.28/Sash
10 Lite	19.28/Sash
16 Lite	46.40/Sash
20 Lite	67.60/Sash

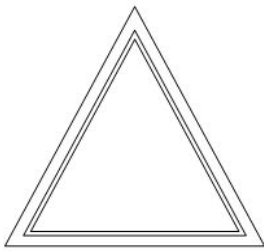

**Series 6000 Isosceles Triangle**

**Vinyl Fixed Triangle Windows**

United Incl	1-Lite	Low-E	Tempered	Primed 4-9/16"	Primed 6-9/16"
				Jamb Ext.	Jamb Ext.
0 - 60	507.00	2.92/sqft	14.04/sqft	192.00	261.00
61 - 84	564.00	2.92/sqft	14.04/sqft	192.00	261.00
85 - 108	621.00	2.92/sqft	14.04/sqft	192.00	261.00
109 - 132	805.00	2.92/sqft	14.04/sqft	192.00	261.00
<b>No Other Sizes Available</b>					

\* United Inch is width + height using the widest and tallest points

\* **Windows with over 30 sqft of glass are required to be tempered**

Grilles	
2 Lite	12.20/Sash
4 Lite	12.20/Sash
6 Lite	14.60/Sash
8 Lite	16.08/Sash
9 Lite	19.28/Sash
10 Lite	19.28/Sash
16 Lite	46.40/Sash
20 Lite	67.60/Sash

- Tempered Low-E Glass: Add \$24.85/sqft of Window Area

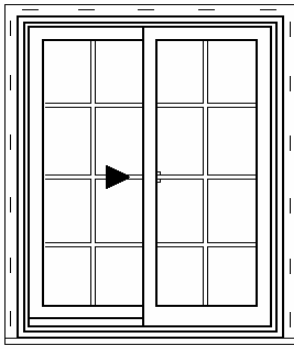

**Series 6600 2SS**

**Vinyl 2-Lite Slider Windows**

- Operating Sash Can Be Removed by Lifting and Taking Out
- Pocket Sill for Better Water Run-Off
- Interlocking Sash with Intergral Sweeplock
- Moving Panel is on Left and Stationary Panel is on Right When Viewed From Outside
- Aluminum Frame, Fiberglass Mesh Half Screen
- 4-9/16" Jamb Extensions Factory Applied:\$64.00
- 6-9/16" Jamb Extensions Factory Applied:\$87.00

**\* Screens Are Not When Purchased By Themselves**

**\*\* Windows with over 30 sqft of glass are required to be tempered**

Stock Size	1/1	GBG	Lite	Low-E	Screen*
2-4 x 2-0	118.85	128.358	4/4	14.76	2.96
2-4 x 3-0	146.59	158.32	6/6	21.58	3.06
2-4 x 3-8	155.92	168.39	8/8	26.12	3.26
2-4 x 4-0	160.69	173.55	8/8	28.39	3.38
2-4 x 4-4	165.53	178.77	8/8	30.66	3.48
2-4 x 5-0	174.84	188.83	12/12	35.20	3.70
2-8 x 2-0	139.85	151.04	4/4	16.87	3.00
2-8 x 3-0	167.59	181.00	6/6	24.66	3.46
2-8 x 3-8	177.78	192.00	8/8	29.85	3.70
2-8 x 4-0	182.76	197.38	8/8	32.44	3.82
2-8 x 4-4	188.01	203.05	8/8	35.04	3.92
2-8 x 5-0	198.01	213.85	12/12	40.23	4.18
3-0 x 2-0	146.59	158.32	4/4	18.98	3.06
3-0 x 3-0	175.26	189.28	6/6	27.74	3.66
3-0 x 3-8	186.17	201.06	8/8	33.58	3.90
3-0 x 4-0	191.20	206.50	8/8	36.50	4.00
3-0 x 4-4	196.77	212.51	8/8	39.42	4.16
3-0 x 5-0	207.26	223.84	12/12	45.26	4.40
3-4 x 2-0	154.59	166.96	4/4	21.09	3.26
3-4 x 3-0	182.97	197.61	6/6	30.82	3.86
3-4 x 3-8	189.22	204.36	8/8	37.31	4.12
3-4 x 4-0	199.81	215.79	8/8	40.56	4.26
3-4 x 4-4	207.11	223.679	8/8	43.80	4.38
3-4 x 5-0	217.60	235.01	12/12	50.29	4.64
4-0 x 2-0	160.69	173.55	4/4	25.31	3.38
4-0 x 3-0	191.20	206.50	6/6	36.99	4.02
4-0 x 3-8	208.31	224.97	8/8	44.77	4.48
4-0 x 4-0	212.58	229.59	8/8	48.67	4.64
4-0 x 4-4	220.11	237.72	8/8	52.56	4.84
4-0 x 5-0	236.78	255.72	12/12	60.35	5.60
5-0 x 2-0	174.84	188.83	6/6	31.63	3.70
5-0 x 3-0	207.26	223.84	9/9	46.23	4.40
5-0 x 3-8	225.97	244.05	9/9	55.97	4.88
5-0 x 4-0	236.78	255.72	9/9	60.83	5.60
5-0 x 4-4	246.50	266.22	9/9	65.70	6.25
5-0 x 5-0	273.05	294.89	18/18	75.43	6.68
6-0 x 2-0	189.71	204.89	6/6	37.96	4.02
6-0 x 3-0	216.93	234.28	9/9	55.48	4.78
6-0 x 3-8	237.06	256.02	9/9	67.16	5.30
6-0 x 4-0	256.78	277.32	9/9	73.00	6.68
6-0 x 4-4	266.40	287.71	9/9	78.84	7.25
6-0 x 5-0	278.52	300.80	18/18	90.52	7.98
<b>Custom Size</b>	Next Larger Size + 38.50			+2.92 per sqft	+8.00

**MGM Industries**

287 Freehill Road

Hendersonville, TN 37075

Office 1-800-476-5584

Fax 1-615-822-6581

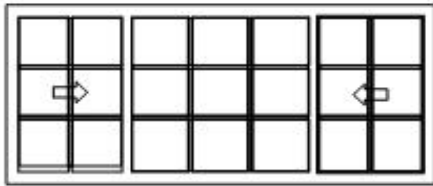

\* Standard Size: 1/4 x 1/2 x 1/4

## Series 6600 3SS

### Vinyl 3-Lite Slider Windows

#### Standard Features

- Operating Sash Can Be Removed by Lifting and Taking Out
- Pocket Sill for Better Water Run-Off
- Interlocking Sash with Intergral Sweeplock
- Moving Panel is on Left and Stationary Panel is on Right When Viewed From Outside
- Aluminum Frame, Fiberglass Mesh Half Screen
- 4-9/16" Jamb Extensions Factory Applied:\$64.00
- 6-9/16" Jamb Extensions Factory Applied:\$87.00

Stock Size	1/1	GBG	Lite	Low-E	Screen*
5-0 x 2-0	218.55	236.03	4/4	29.20	3.70
5-0 x 3-0	259.08	279.80	6/6	43.80	4.40
5-0 x 4-0	295.98	319.65	6/6	58.40	5.60
5-0 x 5-0	341.31	368.62	8/8	73.00	6.68
6-0 x 2-0	237.14	256.11	4/4	35.04	4.02
6-0 x 3-0	271.16	292.86	6/6	52.56	4.78
6-0 x 4-0	320.98	346.65	6/6	70.08	6.68
6-0 x 5-0	348.15	376.00	8/8	87.60	7.98
7-0 x 2-0	276.66	298.793	4/4	40.88	5.92
7-0 x 3-0	316.36	341.66	6/6	61.32	6.12
7-0 x 4-0	374.47	404.43	6/6	81.76	6.52
7-0 x 5-0	406.18	438.67	8/8	102.20	6.76
8-0 x 2-0	316.18	341.48	8/8	46.72	6.96
8-0 x 3-0	361.55	390.47	10/10	70.08	7.40
8-0 x 4-0	427.97	462.20	4/4	93.44	6.00
8-0 x 5-0	464.20	501.34	6/6	116.80	6.92
9-0 x 2-0	355.71	384.16	6/6	52.56	7.40
9-0 x 3-0	406.74	439.28	8/8	78.84	7.64
9-0 x 4-0	481.46	519.98	8/8	105.12	7.84
9-0 x 5-0	522.23	564.00	10/10	131.40	8.36
<b>All Other Sizes Must Be Quoted</b>					

#### **MGM Industries**

287 Freehill Road  
 Hendersonville, TN 37075  
 Office 1-800-476-5584  
 Fax 1-615-822-6581

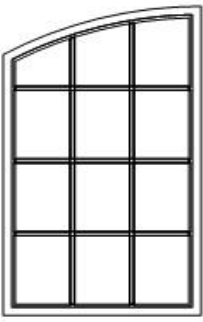

## Series 6000 Extended Quarter Segment Top

Vinyl Extended Quarter Segment Top Picture Windows  
Vinyl Half Segment Windows

Drawing Required on All Orders

Base	Height	1-Lite	GBG	Low-E	Tempered	Primed 4-9/16" Jamb Ext.	Primed 6-9/16" Jamb Ext.
12" - 28"	12"	301.00	328.00	2.92/sqft	14.04/sqft	101.85	124.93
	24"	360.00	393.00				
	36"	421.00	459.00				
	48"	482.00	525.00				
	60"	541.00	590.00				
	72"	617.00	673.00				
	84"	692.00	754.00				
29" - 36"	12"	368.00	401.00	2.92/sqft	14.04/sqft	109.55	144.16
	24"	428.00	467.00				
	36"	489.00	534.00				
	48"	549.00	599.00				
	60"	609.00	664.00				
	72"	699.00	763.00				
	84"	867.00	946.00				
37" - 48"	12"	436.00	476.00	2.92/sqft	14.04/sqft	115.31	153.77
	24"	531.00	579.00				
	36"	632.00	690.00				
	48"	730.00	796.00				
	60"	963.00	1051.00				
	72"	1112.00	1213.00				
49" - 60"	12"	497.00	542.00	2.92/sqft	14.04/sqft	153.77	182.62
	24"	597.00	651.00				
	36"	737.00	804.00				
	48"	978.00	1066.00				
	60"	1143.00	1247.00				
<b>All Other Sizes Must Be Quoted</b>							

- \* Windows with over 30 sqft of glass are required to be tempered
- Tempered Low-E Glass: Add \$24.85/sqft of Window Area
  - **Factory Mull Charge: \$58.50**
  - Mull "Prep": \$18.71 (Unit prepared for job-site mulling)

**MGM Industries**  
287 Freehill Road  
Hendersonville, TN 37075  
Office 1-800-476-5584  
Fax 1-615-822-6581

2/2/07 6000-21



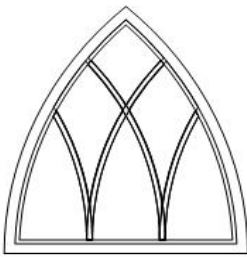

\* Shown with Gothic Grilles

**Series 6000 Arch Top  
Vinyl Gothic Eyebrow Windows**

Size	1-Lite	GBG	Low-E	Tempered	Primed 4-9/16" Jamb Ext.	Primed 6-9/16" Jamb Ext.
2-0 x 2-0	303.00	424.20	11.68	56.16	64.11	89.75
2-4 x 2-4	303.00	424.20	15.90	76.44	71.80	102.57
2-8 x 2-8	303.00	424.20	20.76	99.84	76.93	115.39
3-0 x 3-0	303.00	424.20	26.28	126.36	82.06	128.21
3-4 x 3-4	472.00	660.80	32.44	156.00	89.75	141.03
4-0 x 4-0	472.00	660.80	46.72	224.64	89.75	141.03
5-0 x 5-0	647.00	905.80	73.00	351.00	102.57	153.85
<b>All Other Sizes Must Be Quoted</b>						

- **Gothic Grilles: 40% upcharge**
- Tempered Low-E Glass: Add \$24.84/sqft of Window Area
- **Factory Mull Charge: \$58.50**
- Mull "Prep": \$18.71 (Prepared for job-site mulling)

**MGM Industries**  
 287 Freehill Road  
 Hendersonville, TN 37075  
 Office 1-800-476-5584  
 Fax 1-615-822-6581

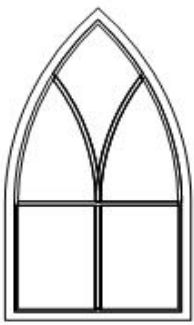

## Series 6000 ATPW

### Arch Top Picture Windows

\*\* Shown with Gothic Grilles

Sizes	Std GBG	1-Lite	GBG	Low-E	Tempered	Primed 4-9/16"	Primed 6-9/16"
						Jamb Ext.	Jamb Ext.
2-0 x 4-0	A23	481.00	524.00	23.36	112.32	128.11	153.75
2-0 x 5-0	A24	540.00	589.00	29.20	140.40	128.11	153.75
2-0 x 6-0	A25	616.00	672.00	35.04	168.48	128.11	153.75
2-0 x 7-0	A26	691.00	753.00	40.88	196.56	128.11	153.75
2-4 x 4-0	B33	481.00	524.00	27.25	131.04	135.80	166.57
2-4 x 5-0	B34	540.00	589.00	34.07	163.80	135.80	166.57
2-4 x 6-0	B35	616.00	672.00	40.88	196.56	135.80	166.57
2-4 x 7-0	B36	691.00	753.00	47.69	229.32	135.80	166.57
2-8 x 4-0	B33	548.00	597.00	31.15	149.76	140.93	179.39
2-8 x 5-0	B34	608.00	663.00	38.93	187.20	140.93	179.39
2-8 x 6-0	B35	698.00	762.00	46.72	224.64	140.93	179.39
2-8 x 7-0	B36	866.00	945.00	54.51	262.08	140.93	179.39
3-0 x 4-0	B33	548.00	597.00	35.04	168.48	146.06	192.21
3-0 x 5-0	B34	608.00	663.00	43.80	210.60	146.06	192.21
3-0 x 6-0	B35	698.00	762.00	52.56	252.72	146.06	192.21
3-0 x 7-0	B36	866.00	945.00	61.32	294.84	146.06	192.21
3-4 x 4-0	C43	729.00	795.00	38.93	187.20	153.75	205.03
3-4 x 5-0	C44	963.00	1050.00	48.67	234.00	153.75	205.03
3-4 x 6-0	C45	1111.00	1212.00	58.40	280.80	153.75	205.03
3-4 x 7-0	C46	1217.00	1327.00	68.13	327.60	153.75	205.03
4-0 x 4-0	C43	729.00	795.00	46.72	224.64	153.75	205.03
4-0 x 5-0	C44	963.00	1050.00	58.40	280.80	153.75	205.03
4-0 x 6-0	C45	1111.00	1212.00	70.08	336.96	153.75	205.03
*4-0 x 7-0	C46	1217.00	1327.00	81.76	393.12	153.75	205.03
5-0 x 5-0	E53	1142.00	1246.00	73.00	351.00	166.57	217.85
5-0 x 6-0	E54	1295.00	1481.00	87.60	421.20	166.57	217.85
*5-0 x 7-0	E55	1377.00	1563.00	102.20	491.40	166.57	217.85
5-4 x 5-0	E53	1195.00	1357.00	77.87	374.40	205.03	243.49
*5-4 x 6-0	E54	1335.00	1527.00	93.44	449.28	205.03	243.49
*5-4 x 7-0	E55	1412.00	1626.00	109.01	524.16	205.03	243.49
6-0 x 5-0	F62	1284.00	1498.00	87.60	421.20	244.03	282.49
*6-0 x 6-0	F63	1463.00	1691.00	105.12	505.44	244.03	282.49
*6-0 x 7-0	F64	1553.00	1795.00	122.64	589.68	244.03	282.49
<b>All Other Sizes Must Be Quoted</b>							

All non-standard grille patterns require drawings for quoting and manufacturing

- See pages 6000-9A & B for RTPW Std GBG patterns.

\* Windows with over 30 sqft of glass are required to be tempered

Patterns with any arch designs (Decralite must be used) are 40% upcharge for ATPW

#### MGM Industries

287 Freehill Road  
Hendersonville, TN 37075  
Office 1-800-476-5584  
Fax 1-615-822-6581

- Tempered Low-E Glass: Add \$24.85/sqft of Window Area

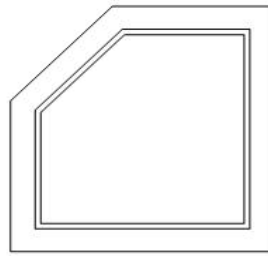
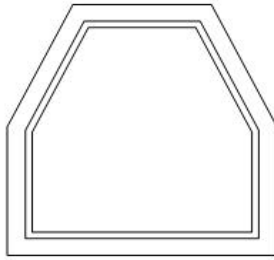
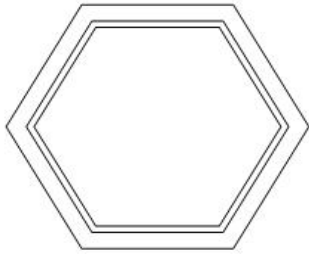

**Series 6000 Hexagon**

**Series 6000 Hex Head**

**Series 6000 Half Hex Head**

Size	1-Lite	GBG	Low-E	Tempered	Primed 4-9/16"	Primed 6-9/16"
					Jamb Ext.	Jamb Ext.
1-8	265.00	293.75	8.11	39.00	384.00	522.00
2-0	265.00	293.75	11.68	56.16	384.00	522.00
2-8	392.50	445.00	20.76	99.84	384.00	522.00
3-0	392.50	445.00	26.28	126.36	384.00	522.00
<b>All Other Sizes Must Be Quoted</b>						

**\* Drawings Are Required On All Orders**

- Tempered Low-E Glass: Add \$24.85/sqft  
of Window Area

**MGM Industries**

287 Freehill Road

Hendersonville, TN 37075

Office 1-800-476-5584

Fax 1-615-822-6581

2/2/07 6000-24

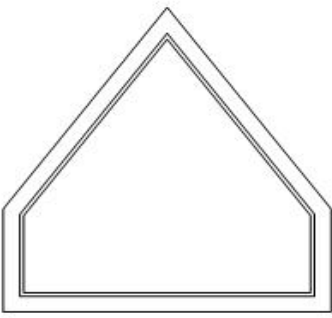

**Series 6000 Pentagon**

United Inch	1-Lite	Low-E	Tempered	Primed 4-9/16"	Primed 6-9/16"
				Jamb Ext.	Jamb Ext.
0 - 60	507.00	2.92/sqft	14.04/sqft	320.00	437.00
61 - 84	564.00	2.92/sqft	14.04/sqft	320.00	437.00
85 - 108	621.00	2.92/sqft	14.04/sqft	320.00	437.00
109 - 132	805.00	2.92/sqft	14.04/sqft	320.00	437.00
<b>All Other Sizes Must Be Quoted</b>					

\* Drawings Are Required On All Orders

\* United Inch is width + height using the widest and tallest points

\* Windows with over 30 sqft of glass are required to be tempered

Grilles	
2 Lite	12.20/Sash
4 Lite	12.20/Sash
6 Lite	14.60/Sash
8 Lite	16.08/Sash
9 Lite	19.28/Sash
10 Lite	19.28/Sash
16 Lite	46.40/Sash
20 Lite	67.60/Sash

- Tempered Low-E Glass: Add \$24.85/sqft of Window Area

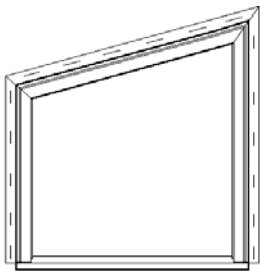

**Series 6000 TRAP**

**Vinyl Fixed Trapezoid Windows**

- Tempered Low-E Glass: Add \$24.85/sqft of Window Area
- **Factory Mull Charge: \$58.50**

\* **Windows with over 30 sqft of glass are required to be tempered**

United Inch	1-Lite	Low-E	Tempered	Primed 4-9/16"	Primed 6-9/16"
				Jamb Ext.	Jamb Ext.
0 - 60	507.00	2.92/sqft	14.04/sqft	256.00	348.00
61 - 84	564.00	2.92/sqft	14.04/sqft	256.00	348.00
85 - 108	621.00	2.92/sqft	14.04/sqft	256.00	348.00
109 - 132	805.00	2.92/sqft	14.04/sqft	256.00	348.00
<b>No Other Sizes Available</b>					

\* United Inch is width + height using the widest and tallest points

Example:

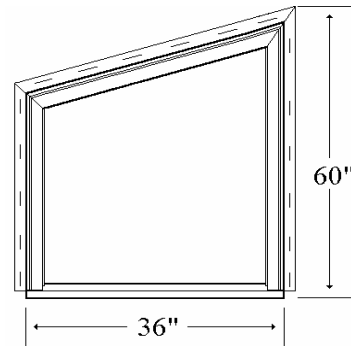

$36" + 60" = 96$  United Inches

**A, B and C Measurements Required**  
(As Viewed From Outside)

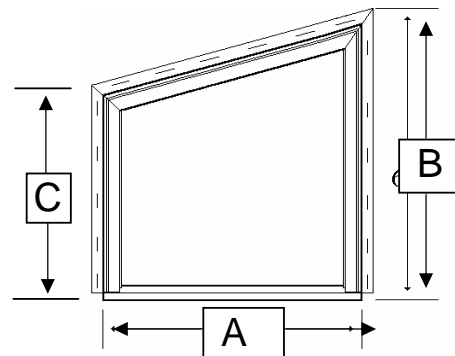

Maximum B Measurement is 9 feet  
 Minimum C Measurement is 6 inches  
**A + B Not To Exceed 132 United Inches**

Grilles	
2 Lite	12.20/Sash
4 Lite	12.20/Sash
6 Lite	14.60/Sash
8 Lite	16.08/Sash
9 Lite	19.28/Sash
10 Lite	19.28/Sash
16 Lite	46.40/Sash
20 Lite	67.60/Sash

**Series 6000 Vinyl Single Hung Rough Opening Chart**

		Factory Mull'd		Units Over 2-8's are Job-Site Mull'd
Size	Single	Twin	Triple	Quad
2-0 x 3-0	24-1/2" x 36-1/2"	49" x 36-1/2"	73-1/2" x 36-1/2"	98" x 36-1/2"
3-8	24-1/2" x 44-1/2"	49" x 44-1/2"	73-1/2" x 44-1/2"	98" x 44-1/2"
4-0	24-1/2" x 48-1/2"	49" x 48-1/2"	73-1/2" x 48-1/2"	98" x 48-1/2"
4-4	24-1/2" x 52-1/2"	49" x 52-1/2"	73-1/2" x 52-1/2"	98" x 52-1/2"
5-0	24-1/2" x 60-1/2"	49" x 60-1/2"	73-1/2" x 60-1/2"	98" x 60-1/2"
6-0	24-1/2" x 72-1/2"	49" x 72-1/2"	73-1/2" x 72-1/2"	98" x 72-1/2"
2-4 x 3-0	28-1/2" x 36-1/2"	57" x 36-1/2"	85-1/2" x 36-1/2"	114" x 36-1/2"
3-8	28-1/2" x 44-1/2"	57" x 44-1/2"	85-1/2" x 44-1/2"	114" x 44-1/2"
4-0	28-1/2" x 48-1/2"	57" x 48-1/2"	85-1/2" x 48-1/2"	114" x 48-1/2"
4-4	28-1/2" x 52-1/2"	57" x 52-1/2"	85-1/2" x 52-1/2"	114" x 52-1/2"
5-0	28-1/2" x 60-1/2"	57" x 60-1/2"	85-1/2" x 60-1/2"	114" x 60-1/2"
6-0	28-1/2" x 72-1/2"	57" x 72-1/2"	85-1/2" x 72-1/2"	114" x 72-1/2"
2-6 x 3-0	30-1/2" x 36-1/2"	61" x 36-1/2"	91-1/2" x 36-1/2"	122" x 36-1/2"
3-8	30-1/2" x 44-1/2"	61" x 44-1/2"	91-1/2" x 44-1/2"	122" x 44-1/2"
4-0	30-1/2" x 48-1/2"	61" x 48-1/2"	91-1/2" x 48-1/2"	122" x 48-1/2"
4-4	30-1/2" x 52-1/2"	61" x 52-1/2"	91-1/2" x 52-1/2"	122" x 52-1/2"
5-0	30-1/2" x 60-1/2"	61" x 60-1/2"	91-1/2" x 60-1/2"	122" x 60-1/2"
6-0	30-1/2" x 72-1/2"	61" x 72-1/2"	91-1/2" x 72-1/2"	122" x 72-1/2"
2-8 x 3-0	32-1/2" x 36-1/2"	65" x 36-1/2"	97-1/2" x 36-1/2"	130" x 36-1/2"
3-8	32-1/2" x 44-1/2"	65" x 44-1/2"	97-1/2" x 44-1/2"	130" x 44-1/2"
4-0	32-1/2" x 48-1/2"	65" x 48-1/2"	97-1/2" x 48-1/2"	130" x 48-1/2"
4-4	32-1/2" x 52-1/2"	65" x 52-1/2"	97-1/2" x 52-1/2"	130" x 52-1/2"
5-0	32-1/2" x 60-1/2"	65" x 60-1/2"	97-1/2" x 60-1/2"	130" x 60-1/2"
6-0	32-1/2" x 72-1/2"	65" x 72-1/2"	97-1/2" x 72-1/2"	130" x 72-1/2"
3-0 x 3-0	36-1/2" x 36-1/2"	73" x 36-1/2"	109-1/2" x 36-1/2"	145-3/4" x 36-1/2"
3-8	36-1/2" x 44-1/2"	73" x 44-1/2"	109-1/2" x 44-1/2"	145-3/4" x 44-1/2"
4-0	36-1/2" x 48-1/2"	73" x 48-1/2"	109-1/2" x 48-1/2"	145-3/4" x 48-1/2"
4-4	36-1/2" x 52-1/2"	73" x 52-1/2"	109-1/2" x 52-1/2"	145-3/4" x 52-1/2"
5-0	36-1/2" x 60-1/2"	73" x 60-1/2"	109-1/2" x 60-1/2"	145-3/4" x 60-1/2"
6-0	36-1/2" x 72-1/2"	73" x 72-1/2"	109-1/2" x 72-1/2"	145-3/4" x 72-1/2"
3-4 x 3-0	40-1/2" x 36-1/2"	81" x 36-1/2"	N/A	161-3/4" x 36-1/2"
3-8	40-1/2" x 44-1/2"	81" x 44-1/2"	N/A	161-3/4" x 44-1/2"
4-0	40-1/2" x 48-1/2"	81" x 48-1/2"	N/A	161-3/4" x 48-1/2"
4-4	40-1/2" x 52-1/2"	81" x 52-1/2"	N/A	161-3/4" x 52-1/2"
5-0	40-1/2" x 60-1/2"	81" x 60-1/2"	N/A	161-3/4" x 60-1/2"
6-0	40-1/2" x 72-1/2"	81" x 72-1/2"	N/A	161-3/4" x 72-1/2"
3-8 x 3-0	44-1/2" x 36-1/2"	89" x 36-1/2"	N/A	177-3/4" x 36-1/2"
3-8	44-1/2" x 44-1/2"	89" x 44-1/2"	N/A	177-3/4" x 44-1/2"
4-0	44-1/2" x 48-1/2"	89" x 48-1/2"	N/A	177-3/4" x 48-1/2"
4-4	44-1/2" x 52-1/2"	89" x 52-1/2"	N/A	177-3/4" x 52-1/2"
5-0	44-1/2" x 60-1/2"	89" x 60-1/2"	N/A	177-3/4" x 60-1/2"
6-0	44-1/2" x 72-1/2"	89" x 72-1/2"	N/A	177-3/4" x 72-1/2"

2-8 and larger Quads are shipped as 2 factory mull'd twins with a precut field H-Mull

**Series 6000 Vinyl Half Round, Transom and Picture Window  
Rough Opening Chart**

<b>Size</b>	<b>Half Round Add to R/O</b>
2-4	14-1/2"
2-6	15-1/2"
2-8	16-1/2"
3-0	18-1/2"
3-4	20-1/2"
3-8	22-1/2"
4-0	24-1/2"
2-0 Twin	24-1/8"
2-4 Twin	28-1/8"
5-0	30-1/2"
2-6 Twin	30-1/8"
1-0 x 3-0 x 1-0	30-1/2"
2-8 Twin	32-1/8"
6-0	36-1/2"
3-0 Twin	36-1/8"
3-4 Twin	40-1/8"
3-8 Twin	44-1/8"

<b>Rectangular Transom</b>	
12"	add 12-1/2"
14"	add 14-1/2"

<b>Segment Transom</b>	
12"	add 12-1/2"
24"	add 24-1/2"

<b>Picture Window</b>	<b>Rough Opening</b>
2-0 x 3-0	24-1/2" x 36-1/2"
2-0 x 3-8	24-1/2" x 44-1/2"
2-0 x 4-0	24-1/2" x 48-1/2"
2-0 x 4-4	24-1/2" x 52-1/2"
2-0 x 5-0	24-1/2" x 60-1/2"
2-0 x 6-0	24-1/2" x 72-1/2"
2-8 x 3-0	32-1/2" x 36-1/2"
2-8 x 3-8	32-1/2" x 44-1/2"
2-8 x 4-0	32-1/2" x 48-1/2"
2-8 x 4-4	32-1/2" x 52-1/2"
2-8 x 5-0	32-1/2" x 60-1/2"
2-8 x 6-0	32-1/2" x 72-1/2"
3-0 x 3-0	36-1/2" x 36-1/2"
3-0 x 3-8	36-1/2" x 44-1/2"
3-0 x 4-0	36-1/2" x 48-1/2"
3-0 x 4-4	36-1/2" x 52-1/2"
3-0 x 5-0	36-1/2" x 60-1/2"
3-0 x 6-0	36-1/2" x 72-1/2"
4-0 x 3-0	48-1/2" x 36-1/2"
4-0 x 3-8	48-1/2" x 44-1/2"
4-0 x 4-0	48-1/2" x 48-1/2"
4-0 x 4-4	48-1/2" x 52-1/2"
4-0 x 5-0	48-1/2" x 60-1/2"
4-0 x 6-0	48-1/2" x 72-1/2"
5-0 x 3-0	60-1/2" x 36-1/2"
5-0 x 3-8	60-1/2" x 44-1/2"
5-0 x 4-0	60-1/2" x 48-1/2"
5-0 x 4-4	60-1/2" x 52-1/2"
5-0 x 5-0	60-1/2" x 60-1/2"
5-0 x 6-0	60-1/2" x 72-1/2"
6-0 x 3-0	72-1/2" x 36-1/2"
6-0 x 3-8	72-1/2" x 44-1/2"
6-0 x 4-0	72-1/2" x 48-1/2"
6-0 x 4-4	72-1/2" x 52-1/2"
6-0 x 5-0	72-1/2" x 60-1/2"
6-0 x 6-0	72-1/2" x 72-1/2"

**MGM Industries**  
 287 Freehill Road  
 Hendersonville, TN 37075  
 Office 1-800-476-5584  
 Fax 1-615-822-6581

**Series 6000 Vinyl 2-Lite and 3-Lite Window  
Rough Opening Chart**

<b>2-Lite Slider Window</b>	<b>Rough Opening</b>
2-4 x 2-0	28-1/2" x 24-1/2"
2-4 x 3-0	28-1/2" x 36-1/2"
2-4 x 3-8	28-1/2" x 44-1/2"
2-4 x 4-0	28-1/2" x 48-1/2"
2-4 x 4-4	28-1/2" x 52-1/2"
2-4 x 5-0	28-1/2" x 60-1/2"
2-8 x 2-0	32-1/2" x 24-1/2"
2-8 x 3-0	32-1/2" x 36-1/2"
2-8 x 3-8	32-1/2" x 44-1/2"
2-8 x 4-0	32-1/2" x 48-1/2"
2-8 x 4-4	32-1/2" x 52-1/2"
2-8 x 5-0	32-1/2" x 60-1/2"
3-0 x 2-0	36-1/2" x 24-1/2"
3-0 x 3-0	36-1/2" x 36-1/2"
3-0 x 3-8	36-1/2" x 44-1/2"
3-0 x 4-0	36-1/2" x 48-1/2"
3-0 x 4-4	36-1/2" x 52-1/2"
3-0 x 5-0	36-1/2" x 60-1/2"
3-4 x 2-0	40-1/2" x 24-1/2"
3-4 x 3-0	40-1/2" x 36-1/2"
3-4 x 3-8	40-1/2" x 44-1/2"
3-4 x 4-0	40-1/2" x 48-1/2"
3-4 x 4-4	40-1/2" x 52-1/2"
3-4 x 5-0	40-1/2" x 60-1/2"
4-0 x 2-0	48-1/2" x 24-1/2"
4-0 x 3-0	48-1/2" x 36-1/2"
4-0 x 3-8	48-1/2" x 44-1/2"
4-0 x 4-0	48-1/2" x 48-1/2"
4-0 x 4-4	48-1/2" x 52-1/2"
4-0 x 5-0	48-1/2" x 60-1/2"
5-0 x 2-0	60-1/2" x 24-1/2"
5-0 x 3-0	60-1/2" x 36-1/2"
5-0 x 3-8	60-1/2" x 44-1/2"
5-0 x 4-0	60-1/2" x 48-1/2"
5-0 x 4-4	60-1/2" x 52-1/2"
5-0 x 5-0	60-1/2" x 60-1/2"
6-0 x 2-0	72-1/2" x 24-1/2"
6-0 x 3-0	72-1/2" x 36-1/2"
6-0 x 3-8	72-1/2" x 44-1/2"
6-0 x 4-0	72-1/2" x 48-1/2"
6-0 x 4-4	72-1/2" x 52-1/2"
6-0 x 5-0	72-1/2" x 60-1/2"

<b>3-Lite Slider Window</b>	<b>Rough Opening</b>
5-0 x 2-0	60-1/2" x 24-1/2"
5-0 x 3-0	60-1/2" x 36-1/2"
5-0 x 4-0	60-1/2" x 48-1/2"
5-0 x 5-0	60-1/2" x 60-1/2"
6-0 x 2-0	72-1/2" x 24-1/2"
6-0 x 3-0	72-1/2" x 36-1/2"
6-0 x 4-0	72-1/2" x 48-1/2"
6-0 x 5-0	72-1/2" x 60-1/2"
7-0 x 2-0	84-1/2" x 24-1/2"
7-0 x 3-0	84-1/2" x 36-1/2"
7-0 x 4-0	84-1/2" x 48-1/2"
7-0 x 5-0	84-1/2" x 60-1/2"
8-0 x 2-0	96-1/2" x 24-1/2"
8-0 x 3-0	96-1/2" x 36-1/2"
8-0 x 4-0	96-1/2" x 48-1/2"
8-0 x 5-0	96-1/2" x 60-1/2"
9-0 x 2-0	108-1/2" x 24-1/2"
9-0 x 3-0	108-1/2" x 36-1/2"
9-0 x 4-0	108-1/2" x 48-1/2"
9-0 x 5-0	108-1/2" x 60-1/2"

**MGM Industries**

287 Freehill Road  
Hendersonville, TN 37075  
Office 1-800-476-5584  
Fax 1-615-822-6581



**SERIES #6000 SINGLE HUNG**

Egress Min. Opening Width=20"xMin. Opening Height=22".

**EGRESS SQFT**

**WIDTH**

		Call-Out	2/0	2/4	2/6	2/8	3/0	3/4	3/6	3/8	4/0
		I.W.D.	24	28	30	32	36	40	42	44	48
Call-Out	I.W.D.	Opening	19.531	23.531	25.531	27.531	31.531	35.531	37.531	39.531	43.531
3/0	36	14.000	1.9	2.3	2.5	2.7	3.1	3.5	3.6	3.8	4.2
3/2	38	15.000	2.0	2.5	2.7	2.9	3.3	3.7	3.9	4.1	4.5
3/4	40	16.000	2.2	2.6	2.8	3.1	3.5	3.9	4.2	4.4	4.8
3/6	42	17.000	2.3	2.8	3.0	3.3	3.7	4.2	4.4	4.7	5.1
3/8	44	18.000	2.4	2.9	3.2	3.4	3.9	4.4	4.7	4.9	5.4

**H  
E  
I  
G  
H  
T**

4/0	48	20.000	2.7	3.3	3.5	3.8	4.4	4.9	5.2	5.5	6.0
4/2	50	21.000	2.8	3.4	3.7	4.0	4.6	5.2	5.5	5.8	6.3
4/4	52	22.000	3.0	3.6	3.9	4.2	4.8	5.4	5.7	6.0	6.7
4/6	54	23.000	3.1	3.8	4.1	4.4	5.0	5.7	6.0	6.3	7.0
4/8	56	24.000	3.3	3.9	4.3	4.6	5.3	5.9	6.3	6.6	7.3

5/0	60	26.000	3.5	4.2	4.6	5.0	5.7	6.4	6.8	7.1	7.9
5/2	62	27.000	3.7	4.4	4.8	5.2	5.9	6.7	7.0	7.4	8.2
5/4	64	28.000	3.8	4.6	5.0	5.4	6.1	6.9	7.3	7.7	8.5
5/6	66	29.000	3.9	4.7	5.1	5.5	6.4	7.2	7.6	8.0	8.8
5/8	68	30.000	4.1	4.9	5.3	5.7	6.6	7.4	7.8	8.2	9.1

6/0	72	32.000	4.3	5.2	5.7	6.1	7.0	7.9	8.3	8.8	9.7
-----	----	--------	-----	-----	-----	-----	-----	-----	-----	-----	-----

I.W.D. = Interior Window Dimension

## Series 6600 2-Lite Slider Windows

Egress Min. Opening Width=20"xMin. Opening Hght.=22"

### EGRESS SQFT.

### WIDTH

HEIGHT

		Call-Out	2/0	2/4	2/6	2/8	3/0	3/4	3/6	3/8	4/0
		I.W.D.	24	28	30	32	36	40	42	44	48
Call-Out	I.W.D.	Opening	8.000	10.000	11.000	12.000	14.000	16.000	17.000	18.000	20.000
3/0	36	30.500	1.7	2.1	2.3	2.5	3.0	3.4	3.6	3.8	4.2
3/2	38	32.500	1.8	2.3	2.5	2.7	3.2	3.6	3.8	4.1	4.5
3/4	40	34.500	1.9	2.4	2.6	2.9	3.4	3.8	4.1	4.3	4.8
3/6	42	36.500	2.0	2.5	2.8	3.0	3.5	4.1	4.3	4.6	5.1
3/8	44	38.500	2.1	2.7	2.9	3.2	3.7	4.3	4.5	4.8	5.3
4/0	48	42.500	2.4	3.0	3.2	3.5	4.1	4.7	5.0	5.3	5.9
4/2	50	44.500	2.5	3.1	3.4	3.7	4.3	4.9	5.3	5.6	6.2
4/4	52	46.500	2.6	3.2	3.6	3.9	4.5	5.2	5.5	5.8	6.5
4/6	54	48.500	2.7	3.4	3.7	4.0	4.7	5.4	5.7	6.1	6.7
4/8	56	50.500	2.8	3.5	3.9	4.2	4.9	5.6	6.0	6.3	7.0
5/0	60	54.500	3.0	3.8	4.2	4.5	5.3	6.1	6.4	6.8	7.6
5/2	62	56.500	3.1	3.9	4.3	4.7	5.5	6.3	6.7	7.1	7.8
5/4	64	58.500	3.3	4.1	4.5	4.9	5.7	6.5	6.9	7.3	8.1
5/6	66	60.500	3.4	4.2	4.6	5.0	5.9	6.7	7.1	7.6	8.4
5/8	68	62.500	3.5	4.3	4.8	5.2	6.1	6.9	7.4	7.8	8.7
6/0	72	66.500	3.7	4.6	5.1	5.5	6.5	7.4	7.9	8.3	9.2

I.W.D. = Interior Window Dimension    DLO = Day Light Opening.

### WIDTH

HEIGHT

DLO (XO)		Call-Out	2/0	2/4	2/6	2/8	3/0	3/4	3/6	3/8	4/0
		I.W.D.	24	28	30	32	36	40	42	44	48
Call-Out	I.W.D.	Opening	8.250	10.250	11.250	12.250	14.250	16.250	17.250	18.250	20.250
3/0	36	30.563	1.7	2.1	2.3	2.5	3.0	3.4	3.6	3.8	4.2
4/0	48	42.563	2.4	3.0	3.3	3.5	4.1	4.7	5.0	5.3	5.9
5/0	60	54.563	3.0	3.8	4.2	4.5	5.3	6.1	6.4	6.8	7.6
6/0	72	66.563	3.7	4.6	5.1	5.5	6.5	7.4	7.9	8.3	9.2

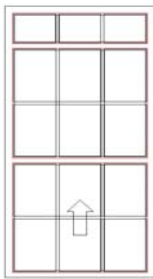

**Series 6400 SH**  
**Vinyl Single Hung Windows**

**Single Units**

- Bottom Sash Tilts In And Can Be Removed
- Interlocking Sash with Intergral Sweeplock
- Custom Sizes Available
- **Full-Sized Window: See Rough Opening Chart**  
 (RO = Single Size + 1/2")
- 4-9/16" Jamb Extensions Factory Applied: \$102.50
- 6-9/16" Jamb Extensions Factory Applied: \$139.00

Overall Height	Available Integral Transom Height
4-0	12"
4-4	12" - 16"
5-0	12" - 24"
6-0	12" - 24"
7-0	12" - 24"

Overall Size	1/1	GBG	Lite	Low-E	Screen	Integral
						Transom
2-0 x 4-0	150.38	160.91	4/4	23.36	2.91	130.69
2-0 x 4-4	154.54	165.36	4/4	25.31	3.00	130.69
2-0 x 5-0	162.56	173.94	4/4	29.20	3.19	130.69
2-0 x 6-0	175.36	187.64	6/6	35.04	3.46	130.69
2-0 x 7-0	188.16	201.33	6/6	40.88	3.73	130.69
2-4 x 4-0	156.20	167.13	6/6	27.25	3.10	144.12
2-4 x 4-4	160.53	171.77	6/6	29.52	3.19	144.12
2-4 x 5-0	168.70	180.51	6/6	34.07	3.39	144.12
2-4 x 6-0	181.65	194.37	9/9	40.88	3.67	144.12
2-4 x 7-0	194.60	208.22	9/9	47.70	3.95	144.12
2-6 x 4-0	162.79	174.19	6/6	29.20	3.19	151.03
2-6 x 4-4	167.21	178.91	6/6	31.63	3.28	151.03
2-6 x 5-0	175.64	187.93	6/6	36.50	3.49	151.03
2-6 x 6-0	185.51	198.50	9/9	43.80	3.78	151.03
2-6 x 7-0	195.38	209.06	9/9	51.10	4.07	151.03
2-8 x 4-0	169.37	181.23	6/6	31.15	3.29	157.94
2-8 x 4-4	173.89	186.06	6/6	33.74	3.37	157.94
2-8 x 5-0	182.57	195.35	6/6	38.93	3.60	157.94
2-8 x 6-0	191.14	204.52	9/9	46.72	3.91	157.94
2-8 x 7-0	199.71	213.69	9/9	54.51	4.22	157.94
3-0 x 4-0	176.64	189.00	6/6	35.04	3.46	171.68
3-0 x 4-4	181.43	194.13	6/6	37.96	3.58	171.68
3-0 x 5-0	190.46	203.79	6/6	43.80	3.79	171.68
3-0 x 6-0	198.79	212.71	9/9	52.56	4.11	171.68
3-0 x 7-0	207.12	221.62	9/9	61.32	4.43	171.68
3-4 x 4-0	184.05	196.93	8/8	38.93	3.67	185.62
3-4 x 4-4	190.34	203.66	8/8	42.18	3.77	185.62
3-4 x 5-0	199.37	213.33	8/8	48.67	3.99	185.62
3-4 x 6-0	207.49	222.01	12/12	58.40	4.34	185.62
3-4 x 7-0	215.61	230.70	12/12	68.14	4.69	185.62
3-8 x 4-0	191.37	204.77	8/8	42.83	3.86	190.10
3-8 x 4-4	196.52	210.28	8/8	46.40	3.98	190.10
3-8 x 5-0	206.57	221.03	8/8	53.53	4.20	190.10
3-8 x 6-0	216.12	231.25	12/12	64.24	4.56	190.10
3-8 x 7-0	225.67	241.47	12/12	74.95	4.92	190.10
<b>Custom Size</b>	Next Larger Size + 38.50			+2.92 per sqft		

\*Screens Are Net When Purchased By Themselves

\*All Heights Are Listed With The Transom

**MGM Industries**  
 287 Freehill Road  
 Hendersonville, TN 37075  
 Office 1-800-476-5584  
 Fax 1-615-822-6581

