

Series 4700 Vinyl Casement Windows

Visit MGMIindustries.com for a complete online catalog

Page

- 1 Singles
- 2 Twins
- 3 Fixed Pictures
- 4 Half Rounds
- 5 Transoms
- 6 Flankers
- 7 Round Top Pictures
- 8 Segment Top Pictures
- 9 Full Rounds
- 10 Ovals
- 11 Segment Top Transoms
- 12 Quarter Top, Gothic, and Half Segment Pictures
- 13 Quarter Rounds
- 14 Octagons
- 15 Triangle
- 16 Isosceles Triangle
- 17 Awnings
- 18 Extended Quarter Segment Top
- 19 Arch Top
- 20 Arch Top Picture
- 21 Pentagon
- 22 Hexagon, Hex Head, and Half Hex Head
- 23 Trapezoid
- 24 Rough Opening Chart 1
- 25 Rough Opening Chart 2
- 26 Egress Chart

Series 4700 Product Information

Test

Result

- | | |
|-------------------------------------|-----------------|
| - Air Infiltration | 0.12 cfm/sq.ft. |
| - Water Resistance at 5 gph/sq.ft. | No Leakage |
| - Water Resistance Rating | DP=50 PSF |
| - Design Pressure | 30 PSF |
| - Max. structural pressure achieved | 45 PSF |
| - Overall rating | H-R40-36x60 |
| - R Value standard clear glass | 2.38* |
| - U Value standard clear glass | 0.42 |
| - R Value Low-E glass | 2.86 |
| - U Value Low-E glass | 0.35 |

* Complete operating unit tested

Minimum and Maximum Build Size

		Operating Window Width					
		1-4	1-6	2-0	2-4	2-6	3-0
H E I G H T	2-0	yes	yes	yes	yes	yes	yes
	4-0	yes	yes	yes	yes	yes	yes
	5-0	yes	yes	yes	yes	yes	yes
	6-0	yes	yes	yes	yes	yes	yes
	7-0	no	no	no	no	no	no

		Fixed Picture Window Width					
		1-0	2-0	3-0	4-0	5-0	6-0
H E I G H T	2-0	yes	yes	yes	yes	yes	yes
	5-0	yes	yes	yes	yes	yes	yes
	6-0	yes	yes	yes	yes	yes	yes
	7-0	no	no	no	no	no	no
	8-0**	no	no	no	no	no	no

** Any unit over 84" in width or height or over 30 sqft must be tempered

		Awning Window Width			
		2-0	3-0	3-4	4-0
H E I G H T	1-6	yes	yes	yes	yes
	2-0	yes	yes	yes	yes
	3-0	yes	yes	yes	yes

Series 4700 Window Options

Standard Features

- Designed for New Home Construction
- Maintenance Free Exterior
- 3/4" Insulated Glass
- Fully Welded Main Frame
- Integral Nailing Fin
- Custom Sizes Available
- 1-15/16" Vinyl Jamb
- 3/4" Grilles
- Available in White and Tan

Options

- Tan Color: Add 10% to List Price
- Obscure Glass: Add \$3.00/sqft of Window Area
- Tempered Glass: Add \$14.04/sqft of Window Area
- Bronze/Gray Tint Glass: Add \$3.00/sqft of Window Area
- Tempered Low-E Glass: Add \$20.70/sqft of Window Area
- Lineal Mull Cap: \$.15/inch
- Factory Mull Charge: \$58.50
- Egress Hardware: Add \$16.86 (Call for availability)
- 4-9/16" Jamb Extensions: Add \$64.00
- 4-9/16" Jamb Extensions for Specialty windows: See Specials pages
- 6-9/16" Jamb Extensions: Add \$87.00
- Full Screen
- Niagra Obscure Glass: Add \$3.30/sqft
- Tempered Niagra Obscure Glass: Add \$21.73/sqft of Window Area
- **Custom grilles (Decralite 1-piece grille): 40% upcharge**
- **Prairie Grilles: 15% upcharge**
- **Prairie (Specialty windows): 40% upcharge**
- **Gothic Grilles: 40% upcharge**
- **SDLs (Net Pricing):** 7/8" WH = \$6.50/lite
7/8" TN = \$7.00/lite
1-1/4" WH = \$7.00/lite
1-1/4" TN = \$7.50/lite

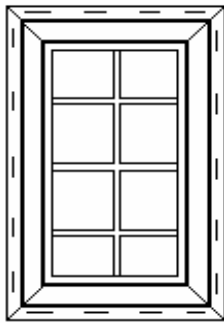

Series 4700 CS

Vinyl Casement Windows

Standard Features

- Opens Fully to 90 Degrees for Easy Cleaning
- Full Interior Screen
- Truth Maxium Hardware with 3-Point Locking System on 30" and Taller Units
- 4-9/16 Jamb Extension: Add \$64.00
- 6-9/16" Jamb Extensions: Add \$87.00

Single Units

Stock Sizes	1/1	GBG	Low-E	Screen
1-6 x 2-0	150.36	156.39	8.76	7.56
1-6 x 3-0	193.32	201.07	13.14	9.72
1-6 x 3-6	214.80	223.41	15.33	10.80
1-6 x 4-0	236.28	245.75	17.52	11.88
1-6 x 4-6	257.76	268.10	19.71	12.96
1-6 x 5-0	279.34	290.54	21.90	14.04
1-6 x 5-6	300.72	312.78	24.09	15.12
1-6 x 6-0	322.20	335.12	26.28	16.20
2-0 x 2-0	171.84	178.73	11.68	8.64
2-0 x 3-0	214.80	223.41	17.52	10.80
2-0 x 3-6	236.28	245.75	20.44	11.88
2-0 x 4-0	257.76	268.10	23.36	12.96
2-0 x 4-6	279.24	290.44	26.28	14.04
2-0 x 5-0	300.72	312.78	29.20	15.12
2-0 x 5-6	322.20	335.12	32.12	16.20
2-0 x 6-0	343.68	357.46	35.04	17.28
2-6 x 2-0	193.32	201.07	14.60	9.72
2-6 x 3-0	236.28	245.75	21.90	11.88
2-6 x 3-6	257.76	268.10	25.55	12.96
2-6 x 4-0	279.24	290.44	29.20	14.04
2-6 x 4-6	300.72	312.78	32.85	15.12
2-6 x 5-0	322.20	335.12	36.50	16.20
2-6 x 5-6	343.68	357.46	40.15	17.28
2-6 x 6-0	365.12	379.76	43.80	18.36
3-0 x 2-0	214.80	223.41	17.52	10.80
3-0 x 3-0	257.76	268.10	26.28	12.63
3-0 x 3-6	286.40	297.88	30.66	14.04
3-0 x 4-0	310.32	322.76	35.04	15.12
3-0 x 4-6	322.20	335.12	39.42	16.20
3-0 x 5-0	362.88	377.43	43.80	17.28
3-0 x 5-6	396.96	412.88	48.18	18.36
3-0 x 6-0	425.04	442.08	52.56	19.44
Custom Size	Next Larger Size + 59.00		2.92/sqft	+20.00

View From Outside

Left Hinge

Right Hinge

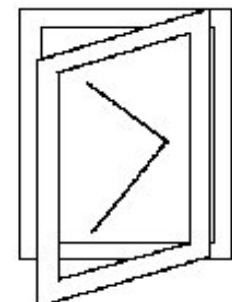
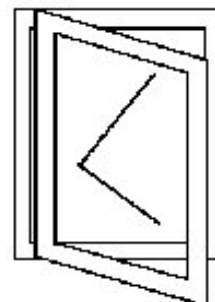

MGM Industries

287 Freehill Road
 Hendersonville, TN 37075
 Office 1-800-476-5584
 Fax 1-615-822-6581

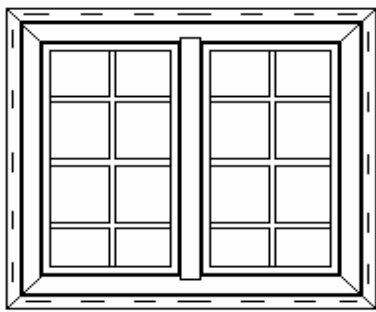

Series 4700 TWIN

Vinyl Casement Windows

Standard Features

- Opens Fully to 90 Degrees for Easy Cleaning
- Full Interior Screen
- Truth Maxium Hardware with 3-Point Locking System on 30" and Taller Units
- 4-9/16 Jamb Extension: Add \$128.00
- 6-9/16" Jamb Extensions: Add \$174.00

Twin Windows

Stock Sizes	1/1	GBG	Low-E	Screen
1-6 x 2-0	319.43	331.49	17.52	15.12
1-6 x 3-0	405.35	420.85	26.28	19.44
1-6 x 3-6	448.31	465.54	30.66	21.60
1-6 x 4-0	491.27	510.22	35.04	23.76
1-6 x 4-6	534.23	554.90	39.42	25.92
1-6 x 5-0	577.39	599.79	43.80	28.08
1-6 x 5-6	620.15	644.27	48.18	30.24
1-6 x 6-0	663.11	688.95	52.56	32.40
2-0 x 2-0	362.39	376.17	23.36	17.28
2-0 x 3-0	448.31	465.54	35.04	21.60
2-0 x 3-6	491.27	510.22	40.88	23.76
2-0 x 4-0	534.23	554.90	46.72	25.92
2-0 x 4-6	577.19	599.59	52.56	28.08
2-0 x 5-0	620.15	644.27	58.40	30.24
2-0 x 5-6	663.11	688.95	64.24	32.40
2-0 x 6-0	706.07	733.63	70.08	34.56
2-6 x 2-0	405.35	420.85	29.20	19.44
2-6 x 3-0	491.27	510.22	43.80	23.76
2-6 x 3-6	534.23	554.90	51.10	25.92
2-6 x 4-0	577.19	599.59	58.40	28.08
2-6 x 4-6	620.15	644.27	65.70	30.24
2-6 x 5-0	663.11	688.95	73.00	32.40
2-6 x 5-6	706.07	733.63	80.30	34.56
2-6 x 6-0	748.95	778.23	87.60	36.72
3-0 x 2-0	448.31	465.54	35.04	21.60
3-0 x 3-0	534.23	554.90	52.56	25.26
3-0 x 3-6	591.51	614.48	61.32	28.08
3-0 x 4-0	639.35	664.24	70.08	30.24
3-0 x 4-6	663.11	688.95	78.84	32.40
3-0 x 5-0	744.47	773.57	87.60	34.56
3-0 x 5-6	812.63	844.47	96.36	36.72
3-0 x 6-0	868.79	902.88	105.12	38.88
Custom Size	Next Larger Size + 118.00		5.84/sqft	+40.00

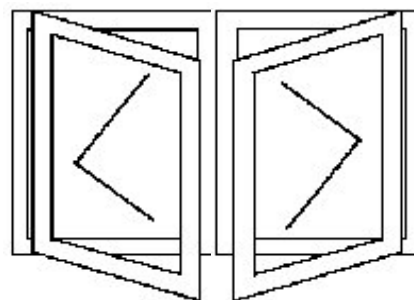

Standard Configuration
View From Outside

MGM Industries

287 Freehill Road

Hendersonville, TN 37075

Office 1-800-476-5584

Fax 1-615-822-6581

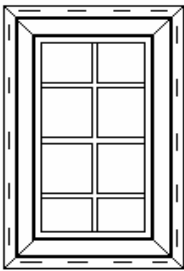

Series 4700 PIC

Vinyl Fixed Casement Windows

Standards

- 4-9/16 Jamb Extension: Add \$64.00
- 6-9/16" Jamb Extensions: Add \$87.00

Fixed Windows

Stock Sizes	I/I	GBG	Low-E	Tempered
1-6 x 2-0	112.77	117.29	8.76	42.12
1-6 x 3-0	144.99	150.80	13.14	63.18
1-6 x 3-6	161.10	167.56	15.33	73.71
1-6 x 4-0	177.21	184.32	17.52	84.24
1-6 x 4-6	193.32	201.07	19.71	94.77
1-6 x 5-0	209.51	217.91	21.90	105.30
1-6 x 5-6	225.54	234.58	24.09	115.83
1-6 x 6-0	241.65	251.34	26.28	126.36
2-0 x 2-0	128.88	134.05	11.68	56.16
2-0 x 3-0	161.10	167.56	17.52	84.24
2-0 x 3-6	177.21	184.32	20.44	98.28
2-0 x 4-0	193.32	201.07	23.36	112.32
2-0 x 4-6	209.43	217.83	26.28	126.36
2-0 x 5-0	225.54	234.58	29.20	140.40
2-0 x 5-6	241.65	251.34	32.12	154.44
2-0 x 6-0	257.76	268.10	35.04	168.48
2-6 x 2-0	144.99	150.80	14.60	70.20
2-6 x 3-0	177.21	184.32	21.90	105.30
2-6 x 3-6	193.32	201.07	25.55	122.85
2-6 x 4-0	209.43	217.83	29.20	140.40
2-6 x 4-6	225.54	233.54	32.85	157.95
2-6 x 5-0	241.65	251.34	36.50	175.50
2-6 x 5-6	257.76	268.10	40.15	193.05
2-6 x 6-0	273.84	284.82	43.80	210.60
3-0 x 2-0	161.10	167.56	17.52	84.24
3-0 x 3-0	193.32	201.07	26.28	126.36
3-0 x 3-6	214.80	223.41	30.66	147.42
3-0 x 4-0	232.74	242.07	35.04	168.48
3-0 x 4-6	241.65	251.34	39.42	189.54
3-0 x 5-0	272.16	283.07	43.80	210.60
3-0 x 5-6	297.72	309.66	48.18	231.66
3-0 x 6-0	318.78	331.56	52.56	252.72
4-0 x 2-0	177.21	184.32	23.36	112.32
4-0 x 3-0	212.65	221.18	35.04	168.48
4-0 x 3-6	236.28	245.75	40.88	196.56
4-0 x 4-0	256.01	266.28	46.72	224.64
4-0 x 4-6	265.82	276.48	52.56	252.72
4-0 x 5-0	299.38	311.39	58.40	280.80
4-0 x 5-6	327.49	340.62	64.24	308.88
4-0 x 6-0	350.66	364.72	70.08	336.96
5-0 x 2-0	194.93	202.75	29.20	140.40
5-0 x 3-0	233.92	243.30	43.80	210.60
5-0 x 3-6	259.91	270.33	51.10	245.70
5-0 x 4-0	281.62	292.91	58.40	280.80
5-0 x 4-6	292.40	304.13	65.70	315.90
5-0 x 5-0	329.31	342.52	73.00	351.00
5-0 x 5-6	360.24	374.69	80.30	386.10
5-0 x 6-0	385.72	401.19	87.60	421.20
6-0 x 2-0	214.42	223.02	35.04	168.48
6-0 x 3-0	257.31	267.63	52.56	252.72
6-0 x 3-6	285.90	297.36	61.32	294.84
6-0 x 4-0	309.78	322.20	70.08	336.96
6-0 x 4-6	321.64	334.54	78.84	379.08
6-0 x 5-0	362.24	376.77	87.60	421.20
*6-0 x 5-6	396.27	412.16	96.36	463.32
*6-0 x 6-0	424.30	441.31	105.12	505.44
Custom Size	Next Larger Size + \$59.00		2.92/sqft	14.04/sqft
* Windows with over 30 sqft of glass are required to be tempered				

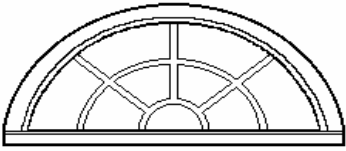

**Series 4700 HR
Vinyl Half Round Windows**

Size	1-Lite	Low-E	Tempered
2-0	273.02	5.84	28.08
2-4	273.02	7.95	38.22
2-6	273.02	9.13	43.88
2-8	273.02	10.38	49.92
3-0	273.02	13.14	63.18
3-4	323.61	16.22	78.00
3-8	367.85	19.63	94.38
4-0 (2-0 Twin)	367.85	23.36	112.32
4-8 (2-4 Twin)	385.35	31.80	152.88
5-0 (2-6 Twin)	409.35	36.50	175.50
5-4 (2-8 Twin)	452.69	41.53	199.68
6-0 (3-0 Twin)	472.76	52.56	252.72
6-8 (3-4 Twin)	529.77	64.89	312.00
7-4 (3-8 Twin)	973.06	78.52	377.52
Custom Size	Next Larger Size +59.00	2.92/sqft	14.04/sqft

Size	Primed 4-9/16" Jamb Ext.	Primed 6-9/16" Jamb Ext.
2-0	64.11	89.75
2-4	71.80	102.57
2-6	76.93	115.39
2-8	76.93	115.39
3-0	82.06	128.21
3-4	89.75	141.03
3-8	89.75	141.03
4-0 (2-0 Twin)	89.75	141.03
4-8 (2-4 Twin)	102.57	153.85
5-0 (2-6 Twin)	102.57	153.85
5-4 (2-8 Twin)	141.03	179.49
6-0 (3-0 Twin)	141.03	179.49
6-8 (3-4 Twin)	150.20	191.16
7-4 (3-8 Twin)	150.20	191.16

**** Must be 2 pcs welded together if over 84"**

** Please specify lettered grille pattern from pages 4700-4A or 4700-4B when ordering

- **Factory Mull Charge: \$58.50**
- Mull "Prep": \$18.71 (Prepared for job-site mulling)
- Tempered Low-E Glass: Add \$24.85/sqft of Window Area

MGM Industries
287 Freehill Road
Hendersonville, TN 37075
Office 1-800-476-5584
Fax 1-615-822-6581

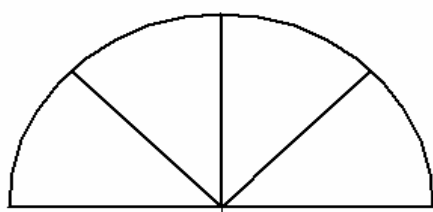

A

3 - Spoke
\$15.60

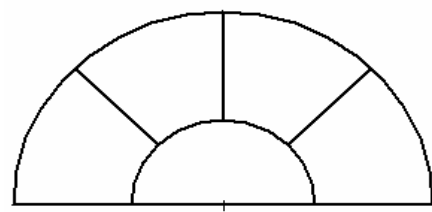

B

3 - Spoke Open Hub
\$24.79

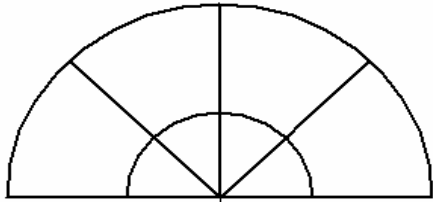

C

3 - Spoke Open Hub Starburst
\$50.04

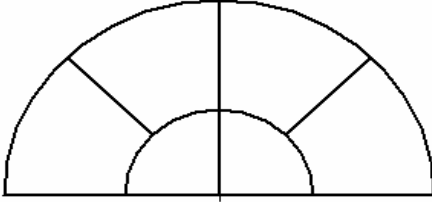

D

3 - Spoke Open Hub Starburst CBO
\$50.04

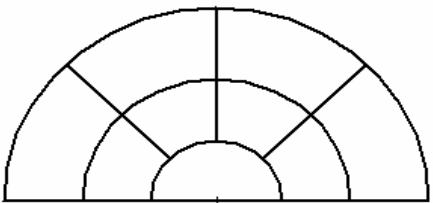

E

3 - Spoke 2-Open Hubs
\$115.95

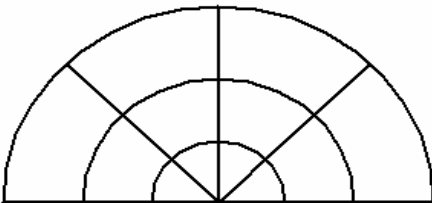

F

3 - Spoke 2-Open Hubs Starburst
\$148.45

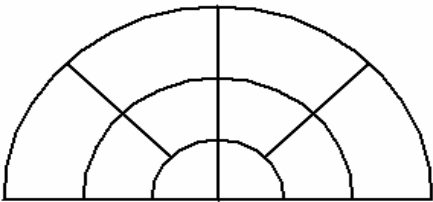

G

3 - Spoke 2-Open Hubs Starburst CBO
\$148.45

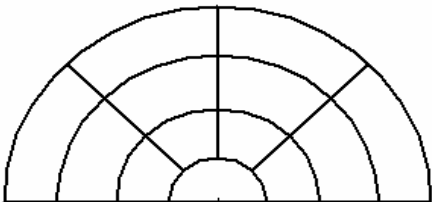

H

3 - Spoke 3-Open Hubs
\$197.20

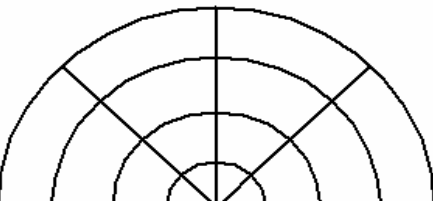

I

3 - Spoke 3-Open Hubs Starburst
\$229.70

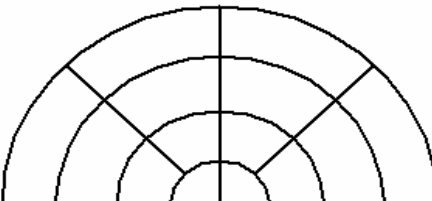

J

3 - Spoke 3-Open Hubs Starburst CBO
\$229.70

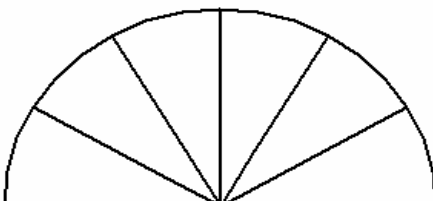

K

5 - Spoke
\$21.19

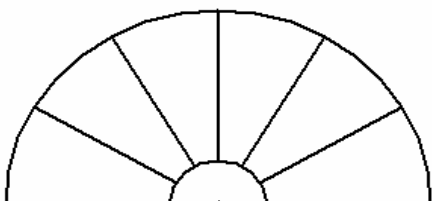

L

5 - Spoke Open Hub
\$36.14

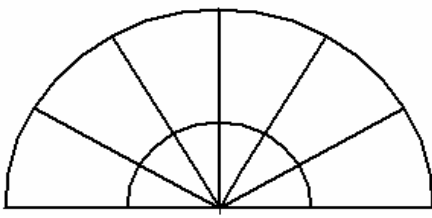

M

5 - Spoke Open Hub Starburst
\$55.64

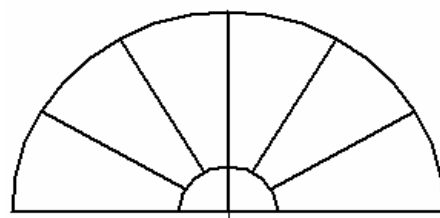

N

5 - Spoke Open Hub Starburst CBO
\$55.64

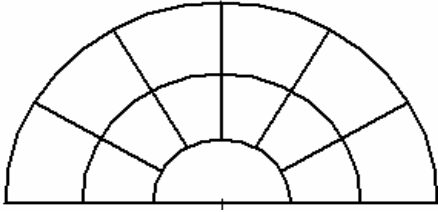

O

5 - Spoke 2-Hub
\$121.54

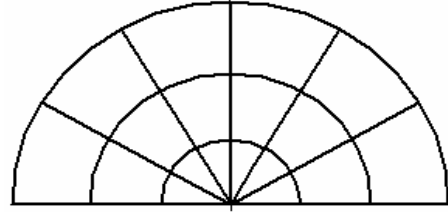

P

5 - Spoke 2-Open Hub Starburst
\$154.04

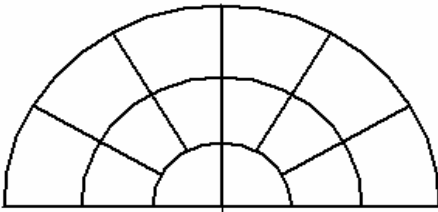

Q

5 - Spoke 2-Open Hub Starburst CBO
\$154.04

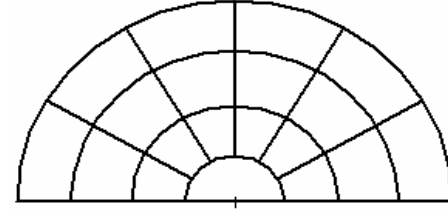

R

5 - Spoke 3-Hub
\$202.79

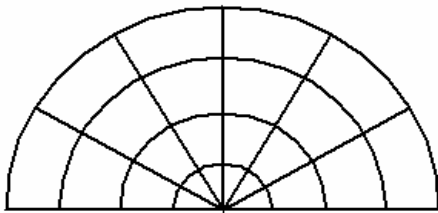

S

5 - Spoke 3-Open Hub Starburst
\$235.29

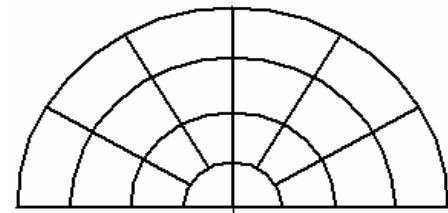

T

5 - Spoke 3-Open Hub Starburst CBO
\$235.29

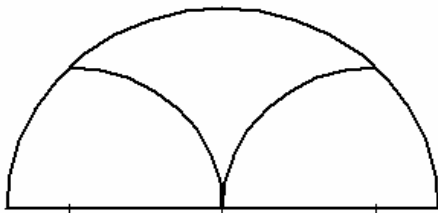

U

1 - Point Gothic

Gothic Patterns
+40% of 1/1 Price

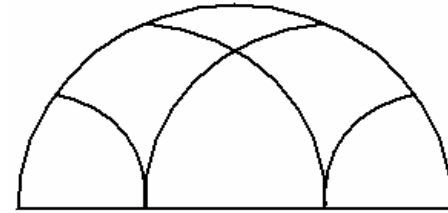

V

2 - Point Gothic

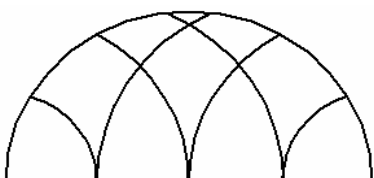

W

3 - Point Gothic

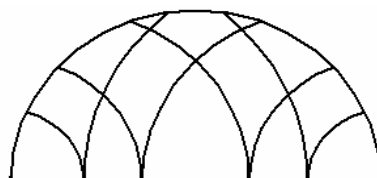

X

4 - Point Gothic

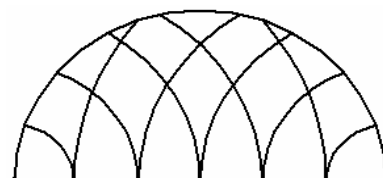

Y

5 - Point Gothic

Note: Gothic Grille Radius will vary somewhat with the width of the Half Round

to check to see if the grille you've picked works in the size Half Round you want

No = Can't use this grille in this size Half Round

NR = Not Recommended due to either appearance or is not architecturally correct but can be built at your risk

Yes = This grille works well in this size Half Round

	Ref Ltr	2-0	2-4	2-6	2-8	3-0	3-4	3-8	4-0	2-0TW
3 - Spoke	A	Yes	NR	NR	NR	NR	Yes	Yes	Yes	Yes
3 - Spoke Open Hub	B	No	Yes	Yes	Yes	Yes	Yes	Yes	Yes	Yes
3 - Spoke Open Hub Starburst	C	No	NR	NR	NR	NR	Yes	Yes	Yes	Yes
3 - Spoke Open Hub Starburst CBO	D	No	NR	NR	NR	NR	Yes	Yes	Yes	Yes
3 - Spoke 2-Open Hubs	E	No	No	No	No	No	No	No	No	No
3 - Spoke 2-Open Hubs Starburst	F	No	No	No	No	No	No	No	No	No
3 - Spoke 2-Open Hubs Starburst CBO	G	No	No	No	No	No	No	No	No	No
3 - Spoke 3-Open Hubs	H	No	No	No	No	No	No	No	No	No
3 - Spoke 3-Open Hubs Starburst	I	No	No	No	No	No	No	No	No	No
3 - Spoke 3-Open Hubs Starburst CBO	J	No	No	No	No	No	No	No	No	No
5 - Spoke	K	No	NR	NR	NR	NR	Yes	Yes	Yes	Yes
5 - Spoke Open Hub	L	No	NR	NR	NR	NR	Yes	Yes	Yes	Yes
5 - Spoke Open Hub Starburst	M	No	No	No	No	No	Yes	Yes	Yes	Yes
5 - Spoke Open Hub Starburst CBO	N	No	No	No	No	No	Yes	Yes	Yes	Yes
5 - Spoke 2-Open Hubs	O	No	No	No	No	No	No	No	No	No
5 - Spoke 2-Open Hubs Starburst	P	No	No	No	No	No	No	No	No	No
5 - Spoke 2-Open Hubs Starburst CBO	Q	No	No	No	No	No	No	No	No	No
5 - Spoke 3-Open Hubs	R	No	No	No	No	No	No	No	No	No
5 - Spoke 3-Open Hubs Starburst	S	No	No	No	No	No	No	No	No	No
5 - Spoke 3-Open Hubs Starburst CBO	T	No	No	No	No	No	No	No	No	No
1 - Point Gothic	U	Yes	NR	NR	NR	NR	NR	NR	NR	NR
2 - Point Gothic	V	No	Yes	Yes	Yes	Yes	NR	NR	NR	NR
3 - Point Gothic	W	No	No	No	No	No	Yes	Yes	Yes	Yes
4 - Point Gothic	X	No	No	No	No	No	No	No	No	No
5 - Point Gothic	Y	No	No	No	No	No	No	No	No	No

to check to see if the grille you've picked works in the size Half Round you want

No = Can't use this grille in this size Half Round

NR = Not Recommended due to either appearance or is not architecturally correct but can be built at your risk

Yes = This grille works well in this size Half Round

	Ref Ltr	2-4TW	5-0	2-6TW	103010	2-8TW	6-0	3-0TW	3-4TW	3-8TW
3 - Spoke	A	Yes	NR	Yes	NR	Yes	Yes	Yes	Yes	Yes
3 - Spoke Open Hub	B	Yes	Yes	Yes	Yes	Yes	Yes	Yes	Yes	Yes
3 - Spoke Open Hub Starburst	C	Yes	NR	Yes	NR	Yes	Yes	Yes	Yes	Yes
3 - Spoke Open Hub Starburst CBO	D	Yes	NR	Yes	NR	Yes	Yes	Yes	Yes	Yes
3 - Spoke 2-Open Hubs	E	Yes	Yes	Yes	Yes	Yes	Yes	Yes	Yes	Yes
3 - Spoke 2-Open Hubs Starburst	F	Yes	NR	Yes	NR	Yes	Yes	Yes	Yes	Yes
3 - Spoke 2-Open Hubs Starburst CBO	G	Yes	NR	Yes	NR	Yes	Yes	Yes	Yes	Yes
3 - Spoke 3-Open Hubs	H	No	No	No	No	No	No	No	Yes	Yes
3 - Spoke 3-Open Hubs Starburst	I	No	No	No	No	No	No	No	Yes	Yes
3 - Spoke 3-Open Hubs Starburst CBO	J	No	No	No	No	No	No	No	Yes	Yes
5 - Spoke	K	Yes	Yes	Yes	NR	Yes	Yes	Yes	Yes	Yes
5 - Spoke Open Hub	L	Yes	Yes	Yes	Yes	Yes	Yes	Yes	Yes	Yes
5 - Spoke Open Hub Starburst	M	Yes	NR	Yes	NR	Yes	Yes	Yes	Yes	Yes
5 - Spoke Open Hub Starburst CBO	N	Yes	NR	Yes	NR	Yes	Yes	Yes	Yes	Yes
5 - Spoke 2-Open Hubs	O	Yes	Yes	Yes	Yes	Yes	Yes	Yes	Yes	Yes
5 - Spoke 2-Open Hubs Starburst	P	Yes	NR	Yes	NR	Yes	Yes	Yes	Yes	Yes
5 - Spoke 2-Open Hubs Starburst CBO	Q	Yes	NR	Yes	NR	Yes	Yes	Yes	Yes	Yes
5 - Spoke 3-Open Hubs	R	No	No	No	No	No	No	No	Yes	Yes
5 - Spoke 3-Open Hubs Starburst	S	No	No	No	No	No	No	No	Yes	Yes
5 - Spoke 3-Open Hubs Starburst CBO	T	No	No	No	No	No	No	No	Yes	Yes
1 - Point Gothic	U	NR	NR	NR	No	NR	NR	NR	No	No
2 - Point Gothic	V	NR	NR	NR	No	NR	NR	NR	No	No
3 - Point Gothic	W	NR	NR	NR	No	NR	NR	NR	No	No
4 - Point Gothic	X	NR	Yes	NR	No	NR	NR	NR	No	No
5 - Point Gothic	Y	Yes	No	Yes	No	Yes	Yes	Yes	No	No

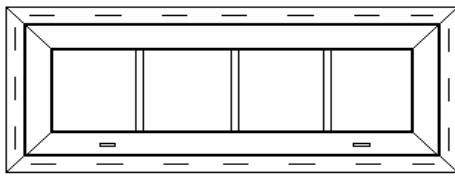

Series 4700 TR

1-Piece Vinyl Fixed Transoms

- Horizontal Mull: \$58.50
- Vertical Mull: Add \$18.71
- Mull "Prep": \$18.71 (Prepared for job-site mulling)
- 4-9/16 Jamb Extension: Add \$38.50
- 6-9/16 Jamb Extension: Add \$52.00

- 2 and 3 Piece Factory Muller Units

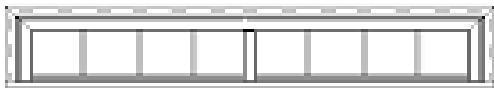

Example: 3/0 Twin x 12" 2-Piece Transom
 Price: \$114.46 + \$114.46 + \$58.50 + \$18.71
 [(3/0 x 12") + (3/0 x 12") + Horizontal Mull
 + Vertical Mull]

**** Please specify 2-piece, 3-piece or
 continuous when ordering**

Stock Sizes	1/1	GBG	Low-E	Tempered
1-6 x 12"	85.90	93.63	4.38	21.06
2-0 x 12"	85.90	93.63	5.84	28.08
2-4 x 12"	95.45	104.04	6.81	32.76
2-6 x 12"	100.22	109.24	7.30	35.10
2-8 x 12"	104.99	114.44	7.79	37.44
3-0 x 12"	114.46	124.76	8.76	42.12
3-8 x 12"	126.88	138.30	10.71	51.48
4-0 x 12"	129.61	141.27	11.68	56.16
5-0 x 12"	137.80	150.20	14.60	70.20
6-0 x 12"	146.02	159.16	17.52	84.24
1-6 x 14"	98.79	107.68	5.11	24.57
2-0 x 14"	98.79	107.68	6.81	32.76
2-4 x 14"	109.77	119.65	7.95	38.22
2-6 x 14"	115.25	125.62	8.52	40.95
2-8 x 14"	120.74	131.61	9.08	43.68
3-0 x 14"	131.63	143.48	10.22	49.14
3-8 x 14"	145.91	159.04	12.49	60.06
4-0 x 14"	149.05	162.46	13.63	65.52
5-0 x 14"	158.48	172.74	17.03	81.90
6-0 x 14"	167.92	183.03	20.44	98.28
Custom Size	Next Larger Size + 59.00		2.92/sqft	14.04/sqft

* Please specify what it is aligning with

** Anything over 96" width or height must be tempered

MGM Industries
 287 Freehill Road
 Hendersonville, TN 37075
 Office 1-800-476-5584
 Fax 1-615-822-6581

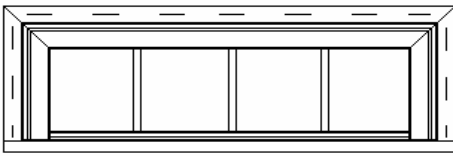

Series 4700 TR

1-Piece Vinyl Fixed Transoms

- Custom Sizes Available
- Horizontal Mull: \$58.50
- Vertical Mull: Add \$18.71
- Mull "Prep": \$18.71 (Prepared for job-site mulling)
- 4-9/16" Jamb Extensions: Add \$38.50
- 6-9/16" Jamb Extensions: Add \$52.00

- 2 and 3 Piece Factory Muller Units

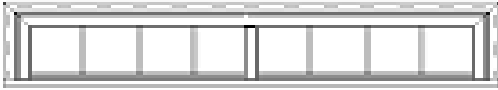

Example: 3/0 Twin x 18" 2-Piece Transom
 Price: \$157.96 + \$157.96 + \$58.50 + \$18.71
 [(3/0 x 18") + (3/0 x 18") + Horizontal Mull
 + Vertical Mull]

**** Please specify 2-piece, 3-piece or continuous when ordering**

Size	1/1	GBG	Low-E	Tempered
2-0x 18"	118.55	129.22	8.76	42.12
2-4 x 18"	131.72	143.57	10.22	49.14
2-6 x 18"	138.30	150.75	10.95	52.65
2-8 x 18"	144.89	157.93	11.68	56.16
3-0 x 18"	157.96	172.18	13.14	63.18
3-8 x 18"	175.09	190.85	16.06	77.22
4-0 x 18"	178.86	194.96	17.52	84.24
5-0 x 18"	190.18	207.30	21.90	105.30
6-0 x 18"	201.50	219.64	26.28	126.36
2-0x 24"	142.26	155.06	11.68	56.16
2-4 x 24"	158.07	172.30	13.63	65.52
2-6 x 24"	165.96	180.90	14.60	70.20
2-8 x 24"	173.87	189.52	15.57	74.88
3-0 x 24"	189.55	206.61	17.52	84.24
3-8 x 24"	210.11	229.02	21.41	102.96
4-0 x 24"	214.63	233.95	23.36	112.32
5-0 x 24"	228.21	248.75	29.20	140.40
6-0 x 24"	241.80	263.56	35.04	168.48
Custom Size	Next Larger Size + 38.50		2.92/sqft	14.04/sqft

*** Windows with an 96 inch or greater length of glass are required to be tempered**

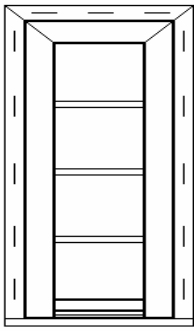

Series 4700 PIC

Vinyl Fixed Flanker Windows

- **Factory Mull Charge: \$18.71**
- Mull "Prep": \$18.71 (Prepared for job-site mulling)
- 4-9/16 Jamb Extension: Add \$38.50
- 6-9/16 Jamb Extension: Add \$52.00

Stock Sizes	1/1	GBG	Low-E	Tempered
12" x 2-0	99.58	108.54	5.84	28.08
12" x 3-0	114.46	124.76	8.76	42.12
12" x 3-6	126.88	138.30	10.22	49.14
12" x 4-0	129.61	141.27	11.68	56.16
12" x 4-6	132.77	144.72	13.14	63.18
12" x 5-0	137.81	150.21	14.60	70.20
12" x 5-6	142.42	155.24	16.06	77.22
12" x 6-0	146.02	159.16	17.52	84.24
14" x 2-0	114.52	124.83	6.81	32.76
14" x 3-0	131.63	143.48	10.22	49.14
14" x 3-6	145.91	159.04	11.92	57.33
14" x 4-0	149.05	162.46	13.63	65.52
14" x 4-6	152.69	166.43	15.33	73.71
14" x 5-0	158.48	172.74	17.03	81.90
14" x 5-6	163.78	178.52	18.74	90.09
14" x 6-0	167.92	183.03	20.44	98.28
Custom Size	Next Larger Size + 59.00		2.92/sqft	14.04/sqft

MGM Industries
 287 Freehill Road
 Hendersonville, TN 37075
 Office 1-800-476-5584
 Fax 1-615-822-6581

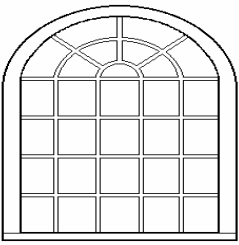

Series 4700 RTPW

Vinyl Round Top Picture Windows

Sizes	Std GBG	1-Lite	GBG	Low-E	Tempered	Primed 4-9/16"	Primed 6-9/16"
						Jamb Ext.	Jamb Ext.
2-0 x 4-0	B33	481.00	524.00	23.36	112.32	128.11	153.75
2-0 x 5-0	B34	540.00	589.00	29.20	140.40	128.11	153.75
2-0 x 6-0	B35	616.00	672.00	35.04	168.48	128.11	153.75
2-0 x 7-0	B36	691.00	753.00	40.88	196.56	128.11	153.75
2-4 x 4-0	B33	481.00	524.00	27.25	131.04	128.11	153.75
2-4 x 5-0	B34	540.00	589.00	34.07	163.80	128.11	153.75
2-4 x 6-0	B35	616.00	672.00	40.88	196.56	128.11	153.75
2-4 x 7-0	B36	691.00	753.00	47.69	229.32	128.11	153.75
2-8 x 4-0	B33	548.00	597.00	31.15	149.76	135.80	166.57
2-8 x 5-0	B34	608.00	663.00	38.93	187.20	135.80	166.57
2-8 x 6-0	B35	698.00	762.00	46.72	224.64	135.80	166.57
2-8 x 7-0	B36	866.00	945.00	54.51	262.08	135.80	166.57
3-0 x 4-0	B33	548.00	597.00	35.04	168.48	140.93	179.39
3-0 x 5-0	B34	608.00	663.00	43.80	210.60	140.93	179.39
3-0 x 6-0	B35	698.00	762.00	52.56	252.72	140.93	179.39
3-0 x 7-0	B36	866.00	945.00	61.32	294.84	140.93	179.39
3-4 x 4-0	C43	729.00	795.00	38.93	187.20	146.06	192.21
3-4 x 5-0	C44	963.00	1050.00	48.67	234.00	146.06	192.21
3-4 x 6-0	C45	1111.00	1221.00	58.40	280.80	146.06	192.21
3-4 x 7-0	C46	1217.00	1350.00	68.13	327.60	146.06	192.21
4-0 x 4-0	C43	729.00	795.00	46.72	224.64	153.75	205.03
4-0 x 5-0	C44	963.00	1050.00	58.40	280.80	153.75	205.03
4-0 x 6-0	C45	1111.00	1221.00	70.08	336.96	153.75	205.03
*4-0 x 7-0	C46	1217.00	1350.00	81.76	393.12	153.75	205.03
5-0 x 5-0	E53	1142.00	1246.00	73.00	351.00	153.75	205.03
5-0 x 6-0	E54	1295.00	1481.00	87.60	421.20	153.75	205.03
*5-0 x 7-0	E55	1377.00	1567.50	102.20	491.40	153.75	205.03
5-4 x 5-0	E53	1195.00	1381.00	77.87	374.40	166.57	217.85
*5-4 x 6-0	E54	1335.00	1530.00	93.44	449.28	166.57	217.85
*5-4 x 7-0	E55	1412.00	1616.00	109.01	524.16	166.57	217.85
6-0 x 5-0	F62	1284.00	1498.00	87.60	421.20	205.03	243.49
*6-0 x 6-0	F63	1463.00	1691.00	105.12	505.44	205.03	243.49
*6-0 x 7-0	F64	1553.00	1795.00	122.64	589.68	205.03	243.49

All Other Sizes Must Be Quoted

* Windows with over 30 sqft of glass are required to be tempered

See pages 4700-7A & B for Std RTPW GBG patterns.

All non-standard grille patterns require drawings for quoting and manufacturing

Tempered Low-E Glass: Add \$24.85/sqft of Window Area

MGM Industries

287 Freehill Road
 Hendersonville, TN 37075
 Office 1-800-476-5584
 Fax 1-615-822-6581

Minimum width for A
is 2-0

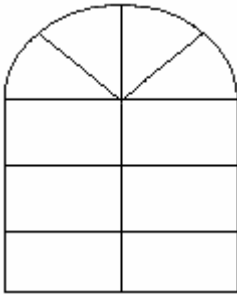

A23

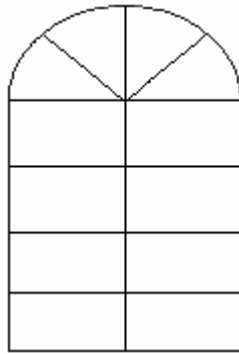

A24

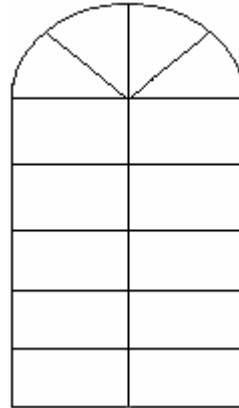

A25

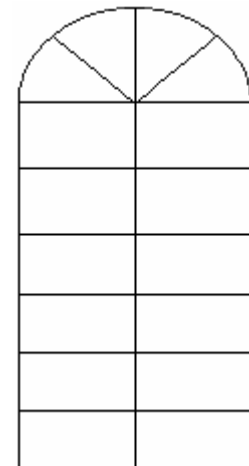

A26

Minimum width for B
is 2-4

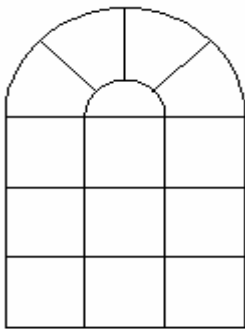

B33

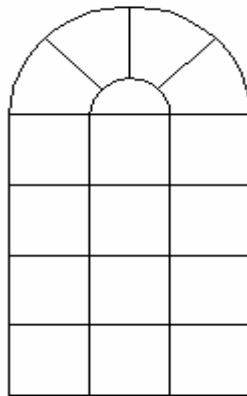

B34

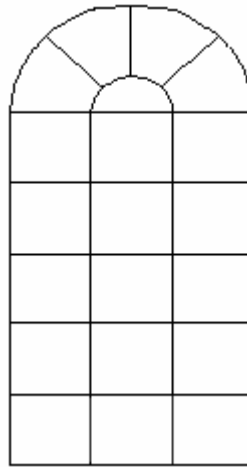

B35

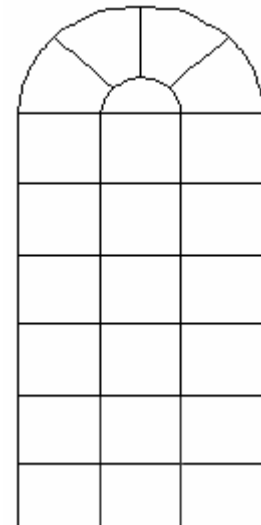

B36

Minimum width for C
is 2-4

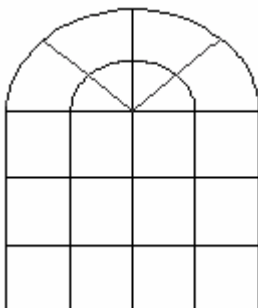

C43

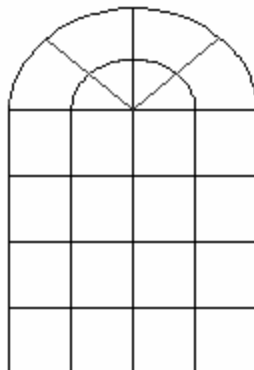

C44

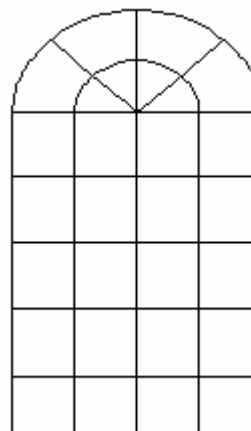

C45

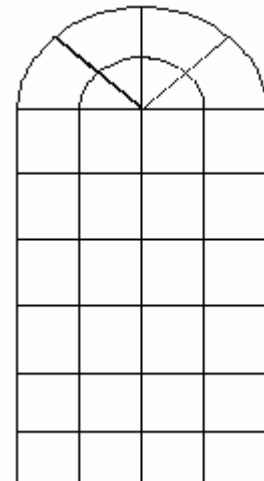

C46

MGM Industries
287 Freehill Road
Hendersonville, TN 37075
Office 1-800-476-5584
Fax 1-615-822-6581

Minimum width for E
is 5-0

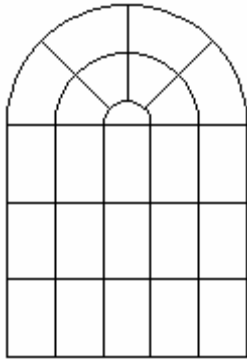

E53

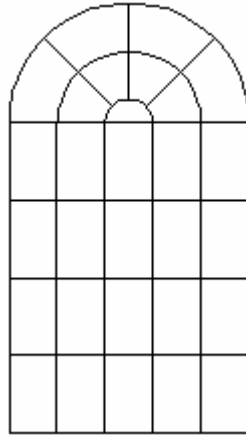

E54

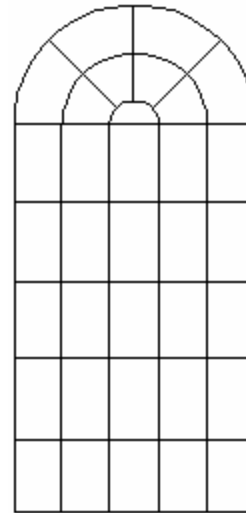

E55

Minimum width for F
is 5-0

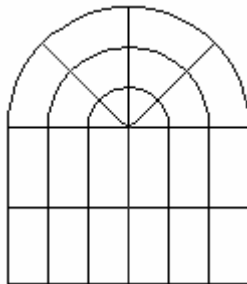

F62

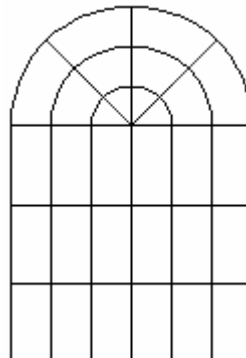

F63

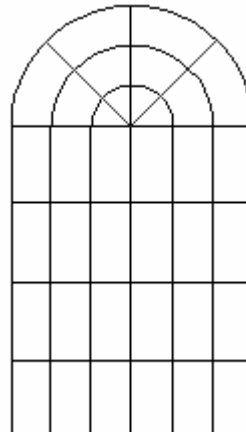

F64

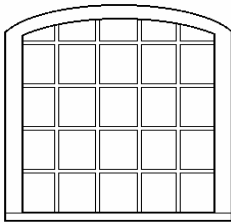

Series 4700 STPW

Vinyl Segment Top Picture Windows

Sizes	1-Lite	GBG	Low-E	Tempered	Primed 4-9/16"	Primed 6-9/16"
					Jamb Ext.	Jamb Ext.
2-0 x 4-0	481.00	524.00	23.36	112.32	128.11	153.75
2-0 x 5-0	540.00	589.00	29.20	140.40	128.11	153.75
2-0 x 6-0	616.00	672.00	35.04	168.48	128.11	153.75
2-0 x 7-0	691.00	753.00	40.88	196.56	128.11	153.75
2-4 x 4-0	481.00	524.00	27.25	131.04	128.11	153.75
2-4 x 5-0	540.00	589.00	34.07	163.80	128.11	153.75
2-4 x 6-0	616.00	672.00	40.88	196.56	128.11	153.75
2-4 x 7-0	691.00	753.00	47.69	229.32	128.11	153.75
2-8 x 4-0	548.00	597.00	31.15	149.76	135.80	166.57
2-8 x 5-0	608.00	663.00	38.93	187.20	135.80	166.57
2-8 x 6-0	698.00	762.00	46.72	224.64	135.80	166.57
2-8 x 7-0	866.00	945.00	54.51	262.08	135.80	166.57
3-0 x 4-0	548.00	597.00	35.04	168.48	140.93	179.39
3-0 x 5-0	608.00	663.00	43.80	210.60	140.93	179.39
3-0 x 6-0	698.00	762.00	52.56	252.72	140.93	179.39
3-0 x 7-0	866.00	945.00	61.32	294.84	140.93	179.39
3-4 x 4-0	729.00	795.00	38.93	187.20	146.06	192.21
3-4 x 5-0	963.00	1050.00	48.67	234.00	146.06	192.21
3-4 x 6-0	1111.00	1221.00	58.40	280.80	146.06	192.21
3-4 x 7-0	1217.00	1350.00	68.13	327.60	146.06	192.21
4-0 x 4-0	729.00	795.00	46.72	224.64	153.75	205.03
4-0 x 5-0	963.00	1050.00	58.40	280.80	153.75	205.03
4-0 x 6-0	1111.00	1221.00	70.08	336.96	153.75	205.03
*4-0 x 7-0	1217.00	1350.00	81.76	393.12	153.75	205.03
5-0 x 5-0	1142.00	1246.00	73.00	351.00	153.75	205.03
5-0 x 6-0	1295.00	1481.00	87.60	421.20	153.75	205.03
*5-0 x 7-0	1377.00	1567.50	102.20	491.40	153.75	205.03
5-4 x 5-0	1195.00	1381.00	77.87	374.40	166.57	217.85
*5-4 x 6-0	1335.00	1530.00	93.44	449.28	166.57	217.85
*5-4 x 7-0	1412.00	1616.00	109.01	524.16	166.57	217.85
6-0 x 5-0	1284.00	1498.00	87.60	421.20	205.03	243.49
*6-0 x 6-0	1463.00	1691.00	105.12	505.44	205.03	243.49
*6-0 x 7-0	1553.00	1795.00	122.64	589.68	205.03	243.49

All Other Sizes Must Be Quoted

* Windows with over 30 sqft of glass are required to be tempered

See pages 4700-7A & B for Std RTPW GBG patterns.

All non-standard grille patterns require drawings for quoting and manufacturing

Standard Patterns with any arch design (Decralite must be used) are 40% upcharge for STPW

Tempered Low-E Glass: Add \$24.85/sqft of Window Area

MGM Industries
 287 Freehill Road
 Hendersonville, TN 37075
 Office 1-800-476-5584
 Fax 1-615-822-6581

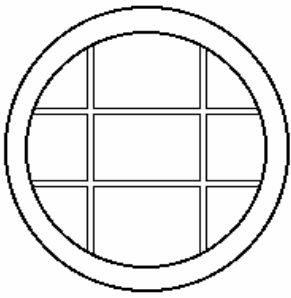

Series 4700 RND

Vinyl Full Round Windows

Diameter	1-Lite	GBG	Low-E	Tempered	Primed 4-9/16"	Primed 6-9/16"
					Jamb Ext.	Jamb Ext.
2-0	564.00	607.00	11.68	56.16	153.86	230.78
2-4	564.00	607.00	15.90	76.44	153.86	230.78
2-8	564.00	607.00	20.76	99.84	153.86	230.78
3-0	564.00	607.00	26.28	126.36	164.12	256.42
4-0	630.00	673.00	46.72	224.64	179.50	282.06
5-0	725.00	767.00	73.00	351.00	205.14	307.70
All Other Sizes Must Be Quoted						

- Tempered Low-E Glass: Add \$24.85/sqft of Window Area
- Custom Grille Available with Drawing

*** Series 4700 Full Rounds are Series 5000
 Full Rounds with Factory Applied Wood
 Extensions and Profile Grilles
 Brick Mould and J-Channel on All Full Round Units**

MGM Industries
 287 Freehill Road
 Hendersonville, TN 37075
 Office 1-800-476-5584
 Fax 1-615-822-6581

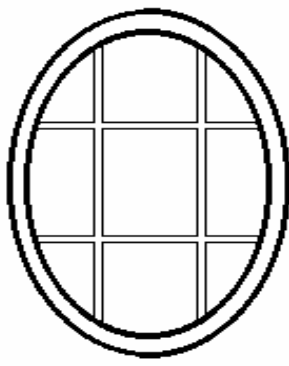

Series 4700 OVAL

Vinyl Fixed Oval Windows

Diameter	1-Lite	GBG	Low-E	Tempered	Primed 4-9/16"	Primed 6-9/16"
					Jamb Ext.	Jamb Ext.
2-0 x 3-0	564.00	625.00	17.52	85.12	153.87	215.40
3-0 x 4-0	630.00	673.00	35.04	169.80	196.95	307.71

- Tempered Low-E Glass: Add \$24.85/sqft of Window Area
- Custom Grille Available with Drawing

*** Series 4700 Ovals are Series
5000 Ovals with Factory Applied
Wood Extensions and Profile Grilles
Brick Mould and J-Channel on All Oval Units**

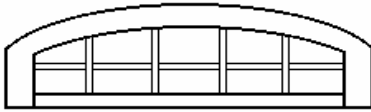

Series 4700 STOP
Vinyl Segment Top Transoms
 1 Piece Transoms



Example using Decralite Grids

Please Specify Leg and CH When Ordering

Size Width x CH*** - Leg****	1-Lite	GBG	Low-E	Tempered	Primed 4-9/16" Jamb Ext.	Primed 6-9/16" Jamb Ext.
2-0 x 12" - 6" Leg	331.20	357.30	5.84	28.08	84.63	126.93
2-4 x 12" - 6" Leg	331.20	357.30	6.82	32.76	84.63	126.93
2-6 x 12" - 6" Leg	331.20	357.30	7.30	35.10	84.63	126.93
2-8 x 12" - 6" Leg	331.20	357.30	7.79	37.44	84.63	126.93
3-0 x 12" - 6" Leg	331.20	357.30	8.76	42.12	90.27	141.04
3-4 x 12" - 6" Leg	392.40	420.30	9.73	46.80	98.73	155.14
3-8 x 12" - 6" Leg	392.40	420.30	10.71	51.48	98.73	155.14
4-0 x 12" - 6" Leg	392.40	420.30	11.68	56.16	98.73	155.14
5-0 x 12" - 6" Leg	447.30	478.40	14.60	70.20	112.83	169.24
6-0 x 12" - 6" Leg	521.20	555.50	17.52	84.24	155.14	197.44
6-8 x 12" - 6" Leg	579.11	617.22	19.47	93.60	165.22	210.28
7-0 x 12" - 6" Leg	608.07	648.09	20.44	98.28	165.22	210.28
7-4 x 12" - 6" Leg**	937.02	978.94	21.41	102.96	165.22	210.28
7-6 x 12" - 6" Leg**	951.50	994.37	21.90	105.30	165.22	210.28
8-0 x 12" - 6" Leg**	994.93	1040.66	23.36	112.32	175.30	223.12
9-0 x 12" - 6" Leg**	1081.80	1133.25	26.28	126.36	185.38	235.96
2-0 x 24" - 6" Leg	413.80	451.10	11.68	56.16	86.32	129.47
2-4 x 24" - 6" Leg	413.80	451.10	13.63	65.52	86.32	129.47
2-6 x 24" - 6" Leg	413.80	451.10	14.60	70.20	86.32	129.47
2-8 x 24" - 6" Leg	413.80	451.10	15.57	74.88	92.08	143.86
3-0 x 24" - 6" Leg	413.80	451.10	17.52	84.24	100.70	158.24
3-4 x 24" - 6" Leg	481.00	524.00	19.47	93.60	100.70	158.24
3-8 x 24" - 6" Leg	481.00	524.00	21.41	102.96	100.70	158.24
4-0 x 24" - 6" Leg	481.00	524.00	23.36	112.32	115.09	172.62
5-0 x 24" - 6" Leg	527.50	584.50	29.20	140.40	158.24	201.39
6-0 x 24" - 6" Leg	600.20	662.20	35.04	168.48	168.52	214.49
6-8 x 24" - 6" Leg	666.89	735.78	38.93	187.20	168.52	214.49
7-0 x 24" - 6" Leg	700.23	772.49	40.88	98.28	168.52	214.49
7-4 x 24" - 6" Leg**	1033.58	1109.29	42.82	102.96	168.52	214.49
7-6 x 24" - 6" Leg**	1050.25	1127.68	43.80	105.30	168.52	214.49
8-0 x 24" - 6" Leg**	1102.67	1185.51	46.72	112.32	178.81	227.58
9-0 x 24" - 6" Leg**	1203.00	1296.20	52.56	126.36	189.09	240.68
All Other Sizes Must Be Quoted						

* Anything over 96" width or height must be tempered

** Only available as 3-piece (Includes 3 piece adder in price)

- Tempered Low-E Glass: Add \$24.85/sqft of Window Area
- **Factory Mull Charge: \$58.50**
- Mull "Prep": \$18.71 (Unit prepared for job-site mulling)
- **Decralite Grilles: Call for Quote**
1 piece grid

*** CH = Center Height of Unit
 **** 6" Leg is shortest available length

Two Piece Stop: Add \$150.00
Three Piece Stop: Add \$300.00

Series 4700 QRPW

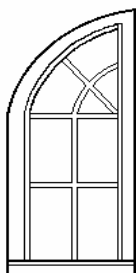

Vinyl Quarter Round Top Picture Windows

Vinyl Gothic Picture Windows

Vinyl Half Segment Windows

Drawing Required on All Orders

Base	Height	1-Lite	GBG	Low-E	Tempered	Primed 4-9/16"	Primed 6-9/16"
						Jamb Ext.	Jamb Ext.
12" - 28"	12"	346.15	377.20	2.92/sqft	14.04/sqft	101.85	124.93
	24"	414.00	451.95				
	36"	484.15	527.85				
	48"	554.30	603.75				
	60"	622.15	678.50				
	72"	709.55	773.95				
	84"	795.80	867.10				
29" - 36"	12"	423.20	461.15	2.92/sqft	14.04/sqft	109.55	144.16
	24"	492.20	537.05				
	36"	562.35	614.10				
	48"	631.35	688.85				
	60"	700.35	763.60				
	72"	803.85	877.45				
	84"	997.05	1087.90				
37" - 48"	12"	501.40	547.40	2.92/sqft	14.04/sqft	115.31	153.77
	24"	610.65	665.85				
	36"	726.80	793.50				
	48"	839.50	915.40				
	60"	1107.45	1208.65				
	72"	1278.80	1394.95				
	84"	1511.25	1603.25				
49" - 60"	12"	571.55	623.30	2.92/sqft	14.04/sqft	153.77	182.62
	24"	686.55	748.65				
	36"	847.55	924.60				
	48"	1124.70	1225.90				
	60"	1314.45	1434.05				
All Other Sizes Must Be Quoted							

- Tempered Low-E Glass: Add \$24.85/sqft of Window Area
- **Factory Mull Charge: \$58.50**
- Mull "Prep": \$18.71 (Unit prepared for job-site mulling)

MGM Industries
 287 Freehill Road
 Hendersonville, TN 37075
 Office 1-800-476-5584
 Fax 1-615-822-6581

2/2/07 4700-12

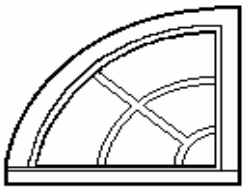

- Tempered Low-E Glass: Add \$24.85/sqft of window Area
- Lineal Mull Cap: \$.15/inch
- **Factory Mull Charge: \$58.50**
- Mull "Prep": \$18.71 (Prepared for job-site mulling)

**Series 4700 QR
Vinyl Quarter Round Windows**

Size	1-Lite	Low-E	Tempered	Primed	Primed
				4-9/16" Jamb Ext.	6-9/16" Jamb Ext.
2-0 x 2-0	303.00	11.68	56.16	64.11	89.75
2-4 x 2-4	303.00	15.90	76.44	71.80	102.57
2-8 x 2-8	303.00	20.76	99.84	76.93	115.39
3-0 x 3-0	303.00	26.28	126.36	82.06	128.21
3-4 x 3-4	472.00	32.44	156.00	89.75	141.03
4-0 x 4-0	472.00	46.72	224.64	89.75	141.03
5-0 x 5-0	647.00	73.00	351.00	102.57	153.85
6-0 x 6-0	875.00	105.12	505.44	141.03	179.49
All Other Sizes Must Be Quoted					

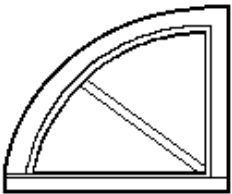

Q1
\$5.00

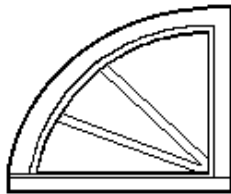

Q2
\$10.00

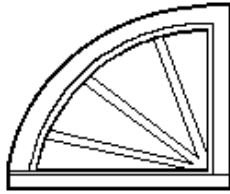

Q3
\$15.00

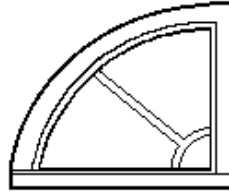

Q4
\$20.00

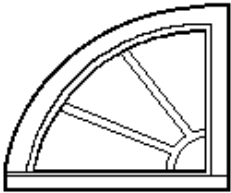

Q5
\$25.00

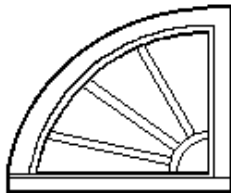

Q6
\$30.00

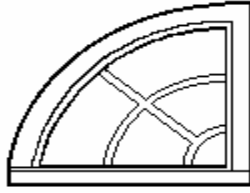

Q7
\$35.00

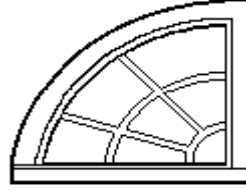

Q8
\$40.00

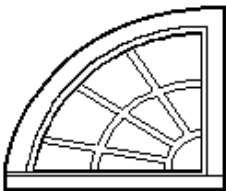

Q9
\$45.00

**All Other Patterns Require
Drawings for Quoting**

MGM Industries
287 Freehill Road
Hendersonville, TN 37075
Office 1-800-476-5584
Fax 1-615-822-6581

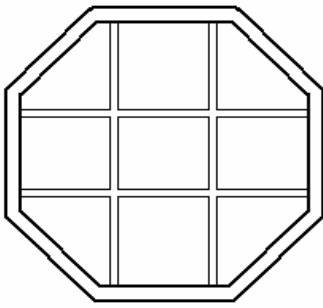

Series 4700 OCT

Vinyl Octagon Windows

Size	1-Lite	GBG	Low-E	Tempered	Primed 4-9/16"	Primed 6-9/16"
					Jamb Ext.	Jamb Ext.
2-0	212.00	235.00	11.68	56.16	64.00	87.00
2-8	314.00	356.00	20.76	99.84	64.00	87.00
3-0	314.00	356.00	26.28	126.36	64.00	87.00
All Other Sizes Must Be Quoted						

* 1-8 Octagon is no longer available

- Tempered Low-E Glass: Add \$24.85/sqft
of Window Area

MGM Industries

287 Freehill Road
Hendersonville, TN 37075
Office 1-800-476-5584
Fax 1-615-822-6581

Series 4700 TRIA

Vinyl Fixed Triangle Windows

- Tempered Low-E Glass: Add \$24.85/sqft of Window Area
- **Factory Mull Charge: \$58.50**

* **Windows with over 30 sqft of glass are required to be tempered**

Grilles	
2 Lite	12.20/Sash
4 Lite	12.20/Sash
6 Lite	14.60/Sash
8 Lite	16.08/Sash
9 Lite	19.28/Sash
10 Lite	19.28/Sash
16 Lite	46.40/Sash
20 Lite	67.60/Sash

				Primed 4-9/16"	Primed 6-9/16"
United Inch	1-Lite	Low-E	Tempered	Jamb Ext.	Jamb Ext.
0 - 60	507.00	2.92/sqft	14.04/sqft	192.00	261.00
61 - 84	564.00	2.92/sqft	14.04/sqft	192.00	261.00
85 - 108	621.00	2.92/sqft	14.04/sqft	192.00	261.00
109 - 132	805.00	2.92/sqft	14.04/sqft	192.00	261.00
No Other Sizes Available					

United Inch is width + height using the widest and tallest points

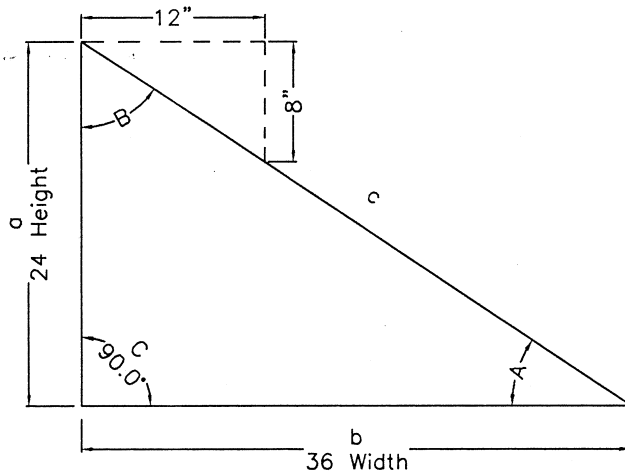

8/12 Roof Pitch
 {for every foot(12") of run, the roof drops 8"}

Minimum TanA allowed is .6666 (TanA=a/b)

When Width & Pitch is Given

- 1) Convert 8/12 to TanA.
 { 8/12 = .666(TanA) }
- 2) Multiply Width x TanA
 { 36 x .6666 = 24 }

When Width & Height is Given

- 1) Convert 24/36 to TanA.
 { 24/36 = .6666(TanA) }

When Pitch & Height is Given

- 1) Convert 8/12 to TanA.
 { 8/12 = .6666(TanA) }
- 2) Convert 24/.6666 to Width.
 { 24 / .6666 = 36 }

a + b Not To Exceed 132 United Inches

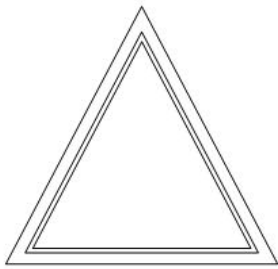

Series 4700 Isosceles Triangle

Vinyl Fixed Triangle Windows

United Inch	1-Lite	Low-E	Tempered	Primed	Primed
				4-9/16"	6-9/16"
				Jamb Ext.	Jamb Ext.
0 - 60	507.00	2.92/sqft	14.04/sqft	192.00	261.00
61 - 84	564.00	2.92/sqft	14.04/sqft	192.00	261.00
85 - 108	621.00	2.92/sqft	14.04/sqft	192.00	261.00
109 - 132	805.00	2.92/sqft	14.04/sqft	192.00	261.00
No Other Sizes Available					

United Inch is width + height using the widest and tallest points

* **Windows with over 30 sqft of glass are required to be tempered**

Grilles	
2 Lite	12.20/Sash
4 Lite	12.20/Sash
6 Lite	14.60/Sash
8 Lite	16.08/Sash
9 Lite	19.28/Sash
10 Lite	19.28/Sash
16 Lite	46.40/Sash
20 Lite	67.60/Sash

- Tempered Low-E Glass: Add \$24.85/sqft of Window Area
- **Factory Mull Charge: \$58.50**

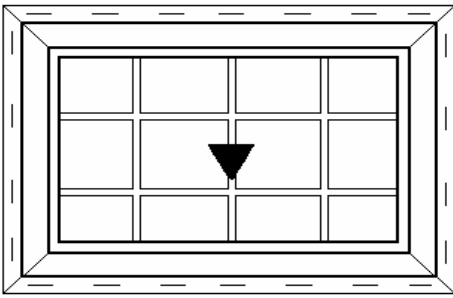

Series 4700 Awn

Vinyl Awning Windows

Stock Sizes	1/1	GBG	Low-E	Tempered	Screen*
2-0 x 1-6	145.46	155.64	8.76	42.12	3.42
2-0 x 2-0	163.40	174.84	11.68	56.16	4.56
2-0 x 3-0	211.28	226.07	17.52	84.24	6.84
3-0 x 1-6	190.00	203.30	13.14	63.18	5.13
3-0 x 2-0	211.28	226.07	17.52	84.24	6.84
3-0 x 3-0	250.80	268.36	26.28	126.36	10.26
3-4 x 1-6	211.28	226.07	14.60	70.20	5.70
3-4 x 2-0	228.00	243.96	19.47	93.60	7.60
3-4 x 3-0	266.00	284.62	29.20	140.40	11.40
4-0 x 1-6	228.00	243.96	17.52	84.24	6.84
4-0 x 2-0	250.80	268.36	23.36	112.32	9.12
4-0 x 3-0	285.00	304.95	35.04	168.48	13.68
Custom Size	Next Larger Size + 59.00		2.92/sqft	14.04/sqft	+16.00

***Screens Are Net When Purchased By Themselves**

- Tempered Low-E Glass: Add \$20.70/sqft of Window Area
- Lineal Mull Cap: \$.15/inch
- **Factory Mull Charge: \$58.50**
- 4-9/16" Jamb Extensions: Add \$64.00
- 6-9/16" Jamb Extensions: Add \$87.00
- Custom Grille Available with Drawing

MGM Industries

287 Freehill Road
 Hendersonville, TN 37075
 Office 1-800-476-5584
 Fax 1-615-822-6581

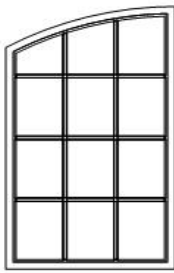

Drawing Required on All Orders

**Series 4700 Extended Quarter Segment Top
Vinyl Extended Quarter Segment Top Windows**

Base	Height	1-Lite	GBG	Low-E	Tempered	Primed 4-9/16"	Primed 6-9/16"
						Jamb Ext.	Jamb Ext.
12" - 28"	12"	346.15	377.20	2.92/sqft	14.04/sqft	101.85	124.93
	24"	414.00	451.95				
	36"	484.15	527.85				
	48"	554.30	603.75				
	60"	622.15	678.50				
	72"	709.55	773.95				
29" - 36"	12"	423.20	461.15	2.92/sqft	14.04/sqft	109.55	144.16
	24"	492.20	537.05				
	36"	562.35	614.10				
	48"	631.35	688.85				
	60"	700.35	763.60				
	72"	803.85	877.45				
37" - 48"	12"	501.40	547.40	2.92/sqft	14.04/sqft	115.31	153.77
	24"	610.65	665.85				
	36"	726.80	793.50				
	48"	839.50	915.40				
	60"	1107.45	1208.65				
	72"	1278.80	1394.95				
49" - 60"	12"	571.55	623.30	2.92/sqft	14.04/sqft	153.77	182.62
	24"	686.55	748.65				
	36"	847.55	924.60				
	48"	1124.70	1225.90				
	60"	1314.45	1434.05				
All Other Sizes Must Be Quoted							

- Tempered Low-E Glass: Add
\$24.85/sqft of Window Area
- **Factory Mull Charge: \$58.50**
- Mull "Prep": \$18.71 (Unit prepared for
job-site mulling)

MGM Industries
287 Freehill Road
Hendersonville, TN 37075
Office 1-800-476-5584
Fax 1-615-822-6581

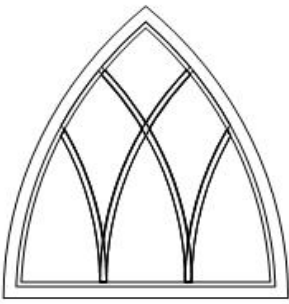

Series 4700 Arch Top

Vinyl Gothic Eyebrow Windows

* Shown with Gothic Grilles

Size	1-Lite	GBG	Low-E	Tempered	Primed 4-9/16"	Primed 6-9/16"
					Jamb Ext.	Jamb Ext.
2-0 x 2-0	303.00	424.20	11.68	56.16	64.11	89.75
2-4 x 2-4	303.00	424.20	15.90	76.44	71.80	102.57
2-8 x 2-8	303.00	424.20	20.76	99.84	76.93	115.39
3-0 x 3-0	303.00	424.20	26.28	126.36	82.06	128.21
3-4 x 3-4	472.00	660.80	32.44	156.00	89.75	141.03
4-0 x 4-0	472.00	660.80	46.72	224.64	89.75	141.03
5-0 x 5-0	647.00	905.80	73.00	351.00	89.75	141.03
All Other Sizes Must Be Quoted						

- **Gothic Grilles: 40% upcharge**
- Tempered Low-E Glass: Add \$24.85/sqft of window Area
- **Factory Mull Charge: \$58.50**
- Mull "Prep": \$18.71 (Prepared for job-site mulling)

MGM Industries

287 Freehill Road
 Hendersonville, TN 37075
 Office 1-800-476-5584
 Fax 1-615-822-6581

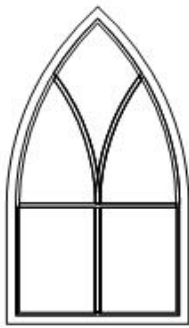

**Series 4700 ATPW
Vinyl Arch Top Picture Windows**

Shown with Gothic Grilles

Sizes	Std GBG	1-Lite	GBG	Low-E	Tempered	Primed 4-9/16"	Primed 6-9/16"
						Jamb Ext.	Jamb Ext.
2-4 x 4-0	B33	481.00	524.00	27.25	131.04	128.11	153.75
2-4 x 5-0	B34	540.00	589.00	34.07	163.80	128.11	153.75
2-4 x 6-0	B35	616.00	672.00	40.88	196.56	128.11	153.75
2-4 x 7-0	B36	691.00	753.00	47.69	229.32	128.11	153.75
2-8 x 4-0	B33	548.00	597.00	31.15	149.76	135.80	166.57
2-8 x 5-0	B34	608.00	663.00	38.93	187.20	135.80	166.57
2-8 x 6-0	B35	698.00	762.00	46.72	224.64	135.80	166.57
2-8 x 7-0	B36	866.00	945.00	54.51	262.08	135.80	166.57
3-0 x 4-0	B33	548.00	597.00	35.04	168.48	140.93	179.39
3-0 x 5-0	B34	608.00	663.00	43.80	210.60	140.93	179.39
3-0 x 6-0	B35	698.00	762.00	52.56	252.72	140.93	179.39
3-0 x 7-0	B36	866.00	945.00	61.32	294.84	140.93	179.39
3-4 x 4-0	C43	729.00	795.00	38.93	187.20	146.06	192.21
3-4 x 5-0	C44	963.00	1050.00	48.67	234.00	146.06	192.21
3-4 x 6-0	C45	1111.00	1221.00	58.40	280.80	146.06	192.21
3-4 x 7-0	C46	1217.00	1350.00	68.13	327.60	146.06	192.21
4-0 x 4-0	C43	729.00	795.00	46.72	224.64	153.75	205.03
4-0 x 5-0	C44	963.00	1050.00	58.40	280.80	153.75	205.03
4-0 x 6-0	C45	1111.00	1221.00	70.08	336.96	153.75	205.03
*4-0 x 7-0	C46	1217.00	1350.00	81.76	393.12	153.75	205.03
5-0 x 5-0	E53	1142.00	1246.00	73.00	351.00	153.75	205.03
5-0 x 6-0	E54	1295.00	1481.00	87.60	421.20	153.75	205.03
*5-0 x 7-0	E55	1377.00	1567.50	102.20	491.40	153.75	205.03
5-4 x 5-0	E53	1195.00	1381.00	77.87	374.40	166.57	217.85
*5-4 x 6-0	E54	1335.00	1530.00	93.44	449.28	166.57	217.85
*5-4 x 7-0	E55	1412.00	1616.00	109.01	524.16	166.57	217.85
6-0 x 5-0	F62	1284.00	1498.00	87.60	421.20	205.03	243.49
*6-0 x 6-0	F63	1463.00	1691.00	105.12	505.44	205.03	243.49
*6-0 x 7-0	F64	1553.00	1795.00	122.64	589.68	205.03	243.49
All Other Sizes Must Be Quoted							

* Windows with over 30 sqft of glass are required to be tempered

See pages 4700-7A & B for Std RTPW GBG patterns.

All non-standard grille patterns require drawings for quoting and manufacturing

Patterns with any arch design (Decralite must be used) patterns are 40% upcharge for ATPW

MGM Industries
287 Freehill Road
Hendersonville, TN 37075
Office 1-800-476-5584
Fax 1-615-822-6581

Tempered Low-E Glass: Add \$24.85/sqft of Window Area

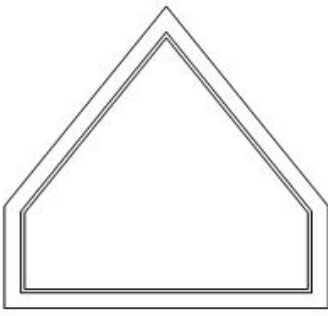

Series 4700 Pentagon

United Incl	1-Lite	Low-E	Tempered	Primed 4-9/16"	Primed 6-9/16"
				Jamb Ext.	Jamb Ext.
0 - 60	507.00	2.92/sqft	14.04/sqft	320.00	435.00
61 - 84	564.00	2.92/sqft	14.04/sqft	320.00	435.00
85 - 108	621.00	2.92/sqft	14.04/sqft	320.00	435.00
109 - 132	805.00	2.92/sqft	14.04/sqft	320.00	435.00
All Other Sizes Must Be Quoted					

*** Drawings Are Required On All Orders**

United Inch is width + height using the widest and tallest points

*** Windows with over 30 sqft of glass are required to be tempered**

Grilles	
2 Lite	12.20/Sash
4 Lite	12.20/Sash
6 Lite	14.60/Sash
8 Lite	16.08/Sash
9 Lite	19.28/Sash
10 Lite	19.28/Sash
16 Lite	46.40/Sash
20 Lite	67.60/Sash

- Tempered Low-E Glass: Add \$24.85/sqft of Window Area

MGM Industries
 287 Freehill Road
 Hendersonville, TN 37075
 Office 1-800-476-5584
 Fax 1-615-822-6581

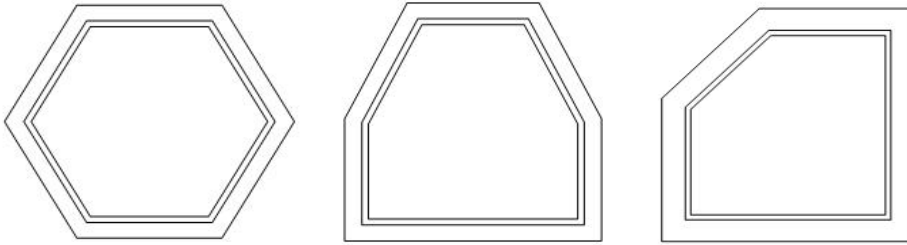

Series 4700 Hexagon

Series 4700 Hex Head

Series 4700 Half Hex Head

Size	1-Lite	GBG	Low-E	Tempered	Primed 4-9/16"	Primed 6-9/16"
					Jamb Ext.	Jamb Ext.
1-8	265.00	293.75	8.11	39.00	384.00	522.00
2-0	265.00	293.75	11.68	56.16	384.00	522.00
2-8	392.50	445.00	20.76	99.84	384.00	522.00
3-0	392.50	445.00	26.28	126.36	384.00	522.00
All Other Sizes Must Be Quoted						

*** Drawings Are Required On All Orders**

- Tempered Low-E Glass: Add
\$24.85/sqft of Window Area

MGM Industries
287 Freehill Road
Hendersonville, TN 37075
Office 1-800-476-5584
Fax 1-615-822-6581

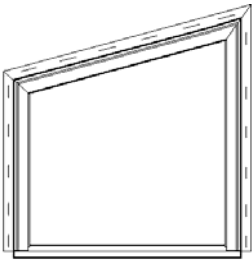

Series 4700 TRAP

Vinyl Fixed Trapezoid Windows

- Tempered Low-E Glass: Add \$24.85/sqft of Window Area

* **Windows with over 30 sqft of glass are required to be tempered**

United Inch	1-Lite	Low-E	Tempered	Primed	Primed
				4-9/16" Jamb Ext.	6-9/16" Jamb Ext.
0 - 60	507.00	2.92/sqft	14.04/sqft	256.00	348.00
61 - 84	564.00	2.92/sqft	14.04/sqft	256.00	348.00
85 - 108	621.00	2.92/sqft	14.04/sqft	256.00	348.00
109 - 132	805.00	2.92/sqft	14.04/sqft	256.00	348.00
No Other Sizes Available					

United Inch is width + height using the widest and tallest points

Example

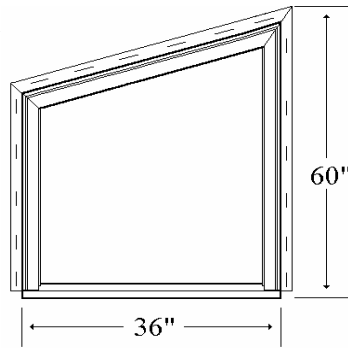

$36" + 60" = 96$ United Inches

A, B and C Measurements Required
(As Viewed From Outside)

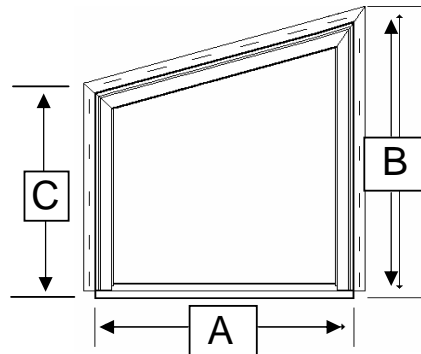

Maximum B Measurement is 9 feet
 Minimum C Measurement is 6 inches
A + B Not To Exceed 132 United Inches

Grilles	
2 Lite	12.20/Sash
4 Lite	12.20/Sash
6 Lite	14.60/Sash
8 Lite	16.08/Sash
9 Lite	19.28/Sash
10 Lite	19.28/Sash
16 Lite	46.40/Sash
20 Lite	67.60/Sash

Series 4700 Vinyl Casement Rough Opening Chart

Size	Single	Twin	Triple
1-6 x 2-0	18" x 24"	35-1/4" x 24"	52-1/2" x 24"
3-0	18" x 36"	35-1/4" x 36"	52-1/2" x 36"
3-6	18" x 42"	35-1/4" x 42"	52-1/2" x 42"
4-0	18" x 48"	35-1/4" x 48"	52-1/2" x 48"
4-6	18" x 54"	35-1/4" x 54"	52-1/2" x 54"
5-0	18" x 60"	35-1/4" x 60"	52-1/2" x 60"
5-6	18" x 66"	35-1/4" x 66"	52-1/2" x 66"
6-0	18" x 72"	35-1/4" x 72"	52-1/2" x 72"
2-0 x 2-0	24" x 24"	47-1/4" x 24"	70-1/2" x 24"
3-0	24" x 36"	47-1/4" x 36"	70-1/2" x 36"
3-6	24" x 42"	47-1/4" x 42"	70-1/2" x 42"
4-0	24" x 48"	47-1/4" x 48"	70-1/2" x 48"
4-6	24" x 54"	47-1/4" x 54"	70-1/2" x 54"
5-0	24" x 60"	47-1/4" x 60"	70-1/2" x 60"
5-6	24" x 66"	47-1/4" x 66"	70-1/2" x 66"
6-0	24" x 72"	47-1/4" x 72"	70-1/2" x 72"
2-6 x 2-0	30" x 24"	59-1/4" x 24"	88-1/2" x 24"
3-0	30" x 36"	59-1/4" x 36"	88-1/2" x 36"
3-6	30" x 42"	59-1/4" x 42"	88-1/2" x 42"
4-0	30" x 48"	59-1/4" x 48"	88-1/2" x 48"
4-6	30" x 54"	59-1/4" x 54"	88-1/2" x 54"
5-0	30" x 60"	59-1/4" x 60"	88-1/2" x 60"
5-6	30" x 66"	59-1/4" x 66"	88-1/2" x 66"
6-0	30" x 72"	59-1/4" x 72"	88-1/2" x 72"
3-0 x 2-0	36" x 24"	71-1/4" x 24"	106-1/2" x 24"
3-0	36" x 36"	71-1/4" x 36"	106-1/2" x 36"
3-6	36" x 42"	71-1/4" x 42"	106-1/2" x 42"
4-0	36" x 48"	71-1/4" x 48"	106-1/2" x 48"
4-6	36" x 54"	71-1/4" x 54"	106-1/2" x 54"
5-0	36" x 60"	71-1/4" x 60"	106-1/2" x 60"
5-6	36" x 66"	71-1/4" x 66"	106-1/2" x 66"
6-0	36" x 72"	71-1/4" x 72"	106-1/2" x 72"

MGM Industries

287 Freehill Road

Hendersonville, TN 37075

Office 1-800-476-5584

Fax 1-615-822-6581

2/2/07 4700-24

Series 4700 Vinyl Half Round, Transom and Awning Rough Opening Chart

Size	Half Round Add to R/O
2-0	12"
2-4	14"
2-6	15"
2-8	16"
3-0	18"
3-4	20"
3-8	22"
4-0	24"
2-0 Twin	23-5/8"
2-4 Twin	27-5/8"
5-0	30"
2-6 Twin	29-5/8"
1-0 x 3-0 x 1-0	30"
2-8 Twin	31-5/8"
6-0	36"
3-0 Twin	35-5/8"
3-4 Twin	39-5/8"
3-8 Twin	43-5/8"

Rectangular Transom	
12"	add 12"
14"	add 14"

Awning Window	Rough Opening
2-0 x 1-6	24" x 18"
2-0 x 2-0	24" x 24"
2-0 x 3-0	24" x 36"
3-0 x 1-6	36" x 18"
3-0 x 2-0	36" x 24"
3-0 x 3-0	36" x 36"
3-4 x 1-6	40" x 18"
3-4 x 2-0	40" x 24"
3-4 x 3-0	40" x 36"
4-0 x 1-6	48" x 18"
4-0 x 2-0	48" x 24"
4-0 x 3-0	48" x 36"

MGM Industries

287 Freehill Road

Hendersonville, TN 37075

Office 1-800-476-5584

Fax 1-615-822-6581

Series 4700 Casement Windows

Egress WIDTH

		Call-Out	1-6	2-0	2-4	2-6	2-8	3-0	
		E.W.D.	17.25	23.25	27.25	29.25	31.25	35.25	
Call-Out	E.W.D.	Opening	6.000	12.000	16.000	18.000	20.000	24.000	
H E I G H T	2-0	23.25	18.6875	0.8	1.6	2.1	2.3	2.6	3.1
	3-0	35.25	30.6875	1.3	2.6	3.4	3.8	4.3	5.1
	3-6	41.25	36.6875	1.5	3.1	4.1	4.6	5.1	6.1
	4-0	47.25	42.6875	1.8	3.6	4.7	5.3	5.9	7.1
	4-6	53.25	48.6875	2.0	4.1	5.4	6.1	6.8	8.1
	5-0	59.25	54.6875	2.3	4.6	6.1	6.8	7.6	9.1
	5-6	65.25	60.6875	2.5	5.1	6.7	7.6	8.4	10.1
	6-0	71.25	66.6875	2.8	5.6	7.4	8.3	9.3	11.1

E.W.D. = Exterior Window Dimension

MGM Industries

287 Freehill Road
 Hendersonville, TN 37075
 Office 1-800-476-5584
 Fax 615-822-6581

2/2/07 4700-26

